

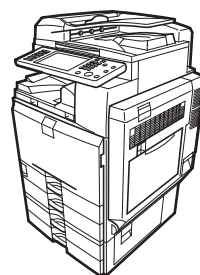

Operating Instructions

General Settings Guide



-
- 1** Connecting the Machine
 - 2** System Settings
 - 3** Copier / Document Server Features
 - 4** Facsimile Features
 - 5** Printer Features
 - 6** Scanner Features
 - 7** Registering Addresses and Users for Facsimile/Scanner Functions
 - 8** Other User Tools
 - 9** Appendix

Read this manual carefully before you use this machine and keep it handy for future reference. For safe and correct use, be sure to read the Safety Information in "About This Machine" before using the machine.

Introduction

This manual contains detailed instructions and notes on the operation and use of this machine. For your safety and benefit, read this manual carefully before using the machine. Keep this manual in a handy place for quick reference.

Important

Contents of this manual are subject to change without prior notice. In no event will the company be liable for direct, indirect, special, incidental, or consequential damages as a result of handling or operating the machine.



Notes:

Some illustrations in this manual might be slightly different from the machine.





Certain options might not be available in some countries. For details, please contact your local dealer.

Depending on which country you are in, certain units may be optional. For details, please contact your local dealer.



Notes:

The model names of the machines do not appear in the following pages. Check the type of your machine before reading this manual.

- Type 1: 25 copies/minute (A4 , 8¹/₂"×11" )
- Type 2: 30 copies/minute (A4 , 8¹/₂"×11" )

Certain types might not be available in some countries. For details, please contact your local dealer.

Two kinds of size notation are employed in this manual. With this machine refer to the metric version.

Manuals for This Machine

Refer to the manuals that are relevant to what you want to do with the machine.

❖ **About This Machine**

Be sure to read the Safety Information in this manual before using the machine.

This manual provides an introduction to the functions of the machine. It also explains the control panel, preparation procedures for using the machine, how to enter text, and how to install the CD-ROMs provided.

❖ **General Settings Guide**

Explains User Tools settings, and Address Book procedures such as registering fax numbers, e-mail addresses, and user codes. Also refer to this manual for explanations on how to connect the machine.

❖ **Troubleshooting**

Provides a guide to solving common problems, and explains how to replace paper, toner, staples, and other consumables.

❖ **Security Reference**

This manual is for administrators of the machine. It explains security functions that the administrators can use to protect data from being tampered, or prevent the machine from unauthorized use.

Also refer to this manual for the procedures for registering administrators, as well as setting user and administrator authentication.

❖ **Copy/ Document Server Reference**

Explains Copier and Document Server functions and operations. Also refer to this manual for explanations on how to place originals.

❖ **Facsimile Reference**

Explains Facsimile functions and operations.

❖ **Printer Reference**

Explains Printer functions and operations.

❖ **Scanner Reference**

Explains Scanner functions and operations.

❖ **Network Guide**

Explains how to configure and operate the machine in a network environment, and use the software provided.

This manual covers all models, and includes descriptions of functions and settings that might not be available on this machine. Images, illustrations, and information about operating systems that are supported might also differ slightly from those of this machine.

❖ Other manuals

- Manuals for This Machine
- Safety Information
- Quick Reference Copy Guide
- Quick Reference Fax Guide
- Quick Reference Printer Guide
- Quick Reference Scanner Guide
- PostScript3 Supplement
- UNIX Supplement
- Manuals for DeskTopBinder Lite
 - DeskTopBinder Lite Setup Guide
 - DeskTopBinder Introduction Guide
 - Auto Document Link Guide

Note

- Manuals provided are specific to machine types.
- Adobe Acrobat Reader/Adobe Reader must be installed in order to view the manuals as PDF files.

TABLE OF CONTENTS

Manuals for This Machine	i
How to Read This Manual	1
Symbols	1
Display Panel	2
Accessing User Tools (System Settings)	3
Changing Default Settings	3
Quitting User Tools	5
Menu Protect.....	5

1. Connecting the Machine

Connecting to the Interfaces	7
Connecting to the Ethernet Interface	8
Connecting to the USB Interface.....	9
Connecting to the IEEE 1394 Interface.....	10
Connecting to the IEEE 1284 Interface.....	11
Connecting to the IEEE 802.11b (Wireless LAN) Interface.....	12
Network Settings	15
Settings Required to Use the Printer/LAN-Fax	15
Settings Required to Use Internet Fax	18
Settings Required to Use E-mail Function	22
Settings Required to Use Scan to Folder Function	26
Settings Required to Use the Network Delivery Scanner.....	29
Settings Required to Use Network TWAIN Scanner	32
Settings Required to Use Document Server	35
Using Utilities to Make Network Settings	38
Connecting the Machine to a Telephone Line and Telephone	47
Connecting the Telephone Line	47
Selecting the Line Type.....	48

2. System Settings

General Features	49
Output tray settings	52
Tray Paper Settings	53
Timer Settings	58
Interface Settings	60
Network.....	60
Parallel Interface	64
IEEE 1394	65
IEEE 802.11b	67
Print List	69
File Transfer	70
Administrator Tools	77
Program / Change/Delete LDAP Server	85
Programming the LDAP server	86

3. Copier / Document Server Features

General Features	91
Reproduction Ratio	96
Edit	100
Stamp	106
Background Numbering	106
Preset Stamp	107
User Stamp	110
Date Stamp	111
Page Numbering	113
Input/Output	116
Adjust Colour Image	119
Settings for the Document Server	120

4. Facsimile Features

General Features	121
Scan Settings	124
Send Settings	125
Reception Settings	128
Initial Settings	134
Reception File Setting	139
Reception Report e-mail	140
Program / Change / Delete Scan Size	141
Deleting a scan size	142
Registering Fax Information	143
Registering Fax Information	144
Deleting Fax Information	146
Forwarding	147
Programming an End Receiver	148
Quitting the forwarding function	150
Forwarding Mark	150
Parameter Settings	151
Changing the User Parameters.....	157
Special Senders to Treat Differently	158
Authorized Reception	159
Reception File Print Quantity	160
Forwarding	160
Print 2 Sided.....	160
Memory Lock.....	161
Paper Tray	161
Programming/Changing Special Senders	162
Authorized RX (Authorized Reception)	164
Reception File Print Qty	164
Forwarding	165
Print 2 Sided.....	166
Memory Lock.....	166
Paper Tray	166
Programming Initial Set Up of a Special Sender	166
Deleting a Special Sender.....	169

Box Settings	170
Programming/Changing Personal Boxes	170
Deleting Personal Boxes	173
Programming/Changing Information Boxes	174
Deleting Information Boxes	177
Programming/Changing Transfer Boxes	178
Deleting Transfer Boxes	181
Printing the Box List	182

5. Printer Features

Test Print	183
Printing the configuration page	184
Interpreting the configuration page	184
Maintenance	186
System	187
Host Interface	191
PCL Menu	192
PS Menu	194
PDF Menu	195

6. Scanner Features

General Settings	197
Scan Settings	199
Send Settings	201

7. Registering Addresses and Users for Facsimile/Scanner Functions

Address Book	203
Managing names in the Address Book	206
Sending fax by Quick Dial	206
Sending e-mail by Quick Dial	207
Sending scanned files to a shared folder directly	207
Preventing unauthorized user access to shared folders from the machine	207
Managing users and machine usage	208
Registering Names	209
Registering Names	209
Changing a Registered Name	210
Deleting a Registered Name	211
Authentication Information	212
Registering a User Code	213
Changing a User Code	214
Deleting a User Code	216
Displaying the Counter for Each User	217
Printing the Counter for Each User	217
Printing the Counter for All User	219
Clearing the Number of Prints	220
Fax Destination	221
Fax Destination	223
IP-Fax Destination	229

E-mail Destination	234
Registering an E-mail Destination.....	234
Changing an E-mail Destination.....	236
Deleting an E-mail Destination.....	237
Registering Folders	238
Using SMB to Connect.....	238
Using FTP to Connect.....	244
Using NCP to Connect.....	249
Registering Names to a Group	255
Registering a Group	255
Registering Names to a Group.....	256
Adding a Group to Another Group	258
Displaying Names Registered in a Group	259
Removing a Name from a Group	260
Deleting a Group Within Another Group	261
Changing a Group Name	263
Deleting a Group	264
Registering a Protection Code	265
Registering a Protection Code to a Single User.....	265
Registering a Protection Code to a Group User.....	267
Registering SMTP and LDAP Authentication	268
SMTP Authentication	268
LDAP Authentication	270

8. Other User Tools

Maintenance	273
Changing the Display Language	274
Enquiry	275
Counter	277
Displaying the Total Counter.....	277

9. Appendix

Specifications for the Main Unit	279
Auto Document Feeder	283
Specifications for Options	284
Information about Installed Software	289
expat	289
NetBSD	290
Sablotron.....	292
JPEG LIBRARY	292
SASL.....	293
MD4.....	294
MD5.....	294
Samba(Ver 3.0.4).....	295
RSA BSAFE®	295
Open SSL.....	296
Open LDAP	301
INDEX	303

How to Read This Manual

Symbols

This manual uses the following symbols:

WARNING:

Indicates important safety notes.

Ignoring these notes could result in serious injury or death. Be sure to read these notes. They can be found in the "Safety Information" section of About This Machine.

CAUTION:

Indicates important safety notes.

Ignoring these notes could result in moderate or minor injury, or damage to the machine or to property. Be sure to read these notes. They can be found in the "Safety Information" section of About This Machine.

Important

Indicates points to pay attention to when using the machine, and explanations of likely causes of paper misfeeds, damage to originals, or loss of data. Be sure to read these explanations.

Note

Indicates supplementary explanations of the machine's functions, and instructions on resolving user errors.

Reference

This symbol is located at the end of sections. It indicates where you can find further relevant information.

[]



Indicates the names of keys that appear on the machine's display panel.

[]

Indicates the names of keys on the machine's control panel.

Display Panel

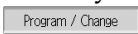
The display panel shows machine status, error messages, and function menus. The function items displayed serve as selector keys. You can select or specify an item by lightly pressing them.

When you select or specify an item on the display panel, it is highlighted like . Keys appearing as  cannot be used.

Important

A force or impact of more than 30 N (about 3 kgf) will damage the display panel.

To display the following screen, press the **[User Tools/Counter]** key to display the User Tools menu, and then press **[System Settings]**.

Using the System Settings menu screen as an example, this section explains how to use the machine's display panel.

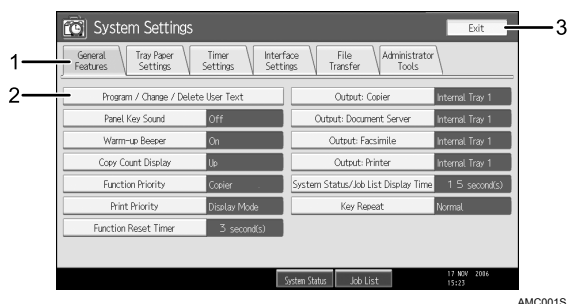

1. The menu tabs for various settings appear. To display the setting you want to specify or change, press the appropriate menu tab.

2. A list of settings appears. To specify or change a setting, press the appropriate key in the list.

3. Press this to quit the User Tools menu.

Accessing User Tools (System Settings)

This section is for Administrators in charge of this machine.

User Tools allow you to change or set defaults.

Note

- Operations for system settings differ from normal operations. Always quit User Tools when you have finished.
- Any changes you make with User Tools remain in effect even if the main power switch or operation switch is turned off, or the **[Energy Saver]** or **[Clear Modes]** key is pressed.
- Default settings are shown in bold type.

Reference

p.5 "Quitting User Tools"

Changing Default Settings

This section describes how to change the settings of User Tools.

Important

- If Administrator Authentication Management is specified, contact your administrator.

1 Press the **[User Tools/Counter]** key.

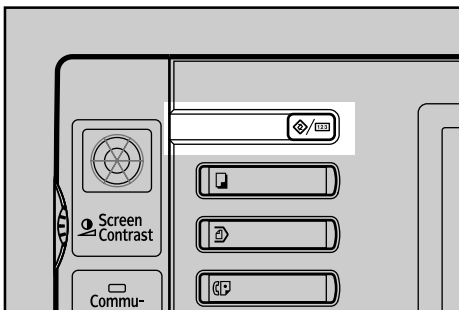

AMG003S

2 Select the menu.

To change the System Settings, Press **[System Settings]**.

To change the Copier / Document Server Features, Press **[Copier / Document Server Features]**.

To change the Facsimile Features, Press **[Facsimile Features]**.

To change the Printer Features, Press **[Printer Features]**.

To change the Scanner Features, Press **[Scanner Features]**.

To adjust colour registration or gradation, press **[Maintenance]**.

To change the language used on the display, press **[English]**.

To check the telephone numbers to contact for repairs, or to order consumables, press **[Enquiry]**.

To check the counter, press **[Counter]**.

3 Select the user tool you want to change.

4 Change settings by following instructions on the display, and then press **[OK]**.

Note

- To cancel changes made to settings and return to the initial display, press the **[User Tools/Counter]** key.

Reference

p.49 "System Settings"

p.91 "Copier / Document Server Features"

p.121 "Facsimile Features"

p.183 "Printer Features"

p.197 "Scanner Features"

p.273 "Other User Tools"

Quitting User Tools

This section describes how to end User Tools.

1 Press the **[User Tools/Counter]** key.

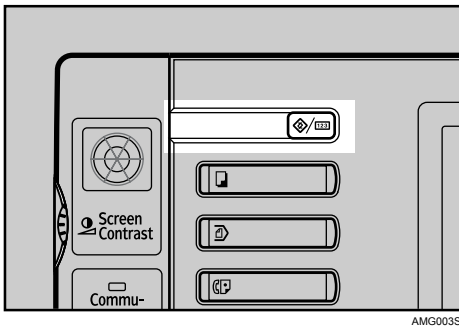

 **Note**

You can also quit User Tools by pressing **[Exit]**.

Menu Protect

Using Menu Protect, you can prevent unauthenticated users from changing the user tools. Menu Protect can be specified for each of the following user tools menus.

- Copier / Document Server Features
- Facsimile Features
- Printer Features
- Scanner Features

For details, consult your administrator.

1. Connecting the Machine

This chapter describes how to connect the machine to the network and specify the network settings.

Connecting to the Interfaces

This section explains how to identify the machine's interface and connect the machine according to the network environment.

When the IEEE 1394 interface board (optional) is installed.

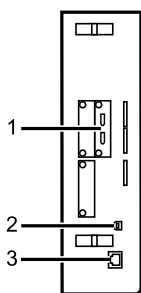

When the IEEE 1284 interface board (optional) is installed.

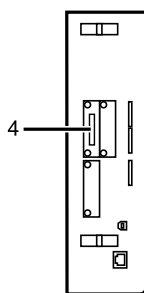

When the wireless LAN board (optional) is installed.

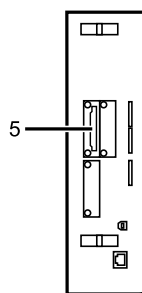

AMC004S

1. IEEE 1394 ports (optional)

Ports for connecting the IEEE 1394 interface cable

2. USB2.0 port

Port for connecting the USB2.0 interface cable

3. 10BASE-T/100BASE-TX port

Port for connecting the 10BASE-T or 100BASE-TX cable

4. IEEE 1284 port (optional)

Port for connecting the IEEE 1284 interface cable

5. Wireless LAN port (optional)

Port for using the wireless LAN

Note

- You cannot install two or more of the options below: IEEE 1394 interface board, IEEE 1284 interface board, IEEE 802.11b wireless LAN

Connecting to the Ethernet Interface

Connect 10BASE-T or 100BASE-TX cable to the Ethernet interface.

1

Important

If the main power switch is on, turn it off.

1 A ferrite core for the Ethernet cable is supplied with this machine. Make a loop in the cable about 15cm (5.9 inch) (①) from the machine end of the cable. Attach the ferrite core.

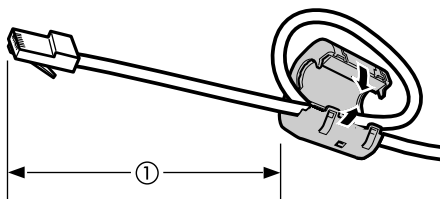

AEV047S

2 Make sure the main power switch of the machine is off.

3 Connect the Ethernet interface cable to the 10BASE-T/100BASE-TX port.

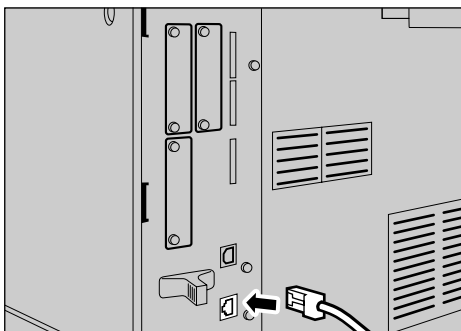

AMB016S

4 Connect the other end of the Ethernet cable to a network connection device such as a hub.

5 Turn on the main power switch of the machine.

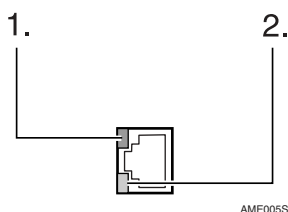

- ① Indicator (green)
Lights up green when the machine is connected correctly to the network.
- ② Indicator (yellow)
Lights up yellow when 100 BASE-TX is in operation. Goes off when 10 BASE-T is in operation.

Note

- For details about installing the printer driver, see "Preparing the Machine", Printer Reference.

Reference

- "Turning On the Power", About This Machine
- "Preparing the Machine", Printer Reference

Connecting to the USB Interface

Connect the USB2.0 interface cable to the USB2.0 port.

1 Connect the USB2.0 interface cable to the USB2.0 port.

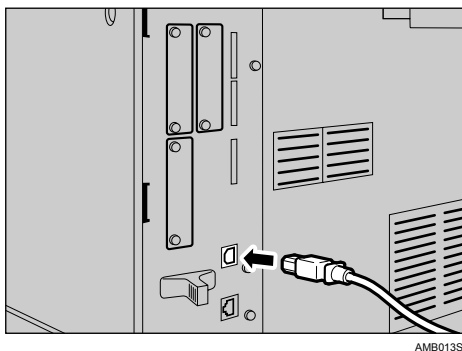

2 Connect the other end to the USB2.0 port on the host computer.

Note

- This machine does not come with a USB interface cable. Make sure you purchase the appropriate cable for the machine and your computer.
- The USB2.0 interface board is supported by Windows 98SE / Me / 2000 / XP, Windows Server 2003, Mac OS X 10.3.3 or higher.
 - For Windows 98SE / Me:
Make sure to install "USB Printing Support". When used with Windows 98SE / Me, only a speed equal to that of USB1.1 is possible.
 - For Mac OS:
To use Macintosh, the machine must be equipped with the optional PostScript 3 unit. When used with Mac OS X 10.3.3 or higher, a transfer speed of USB2.0 is supported.
- For details about installing the printer driver, see "Preparing the Machine", Printer Reference.

Reference

"Preparing the Machine", Printer Reference

Connecting to the IEEE 1394 Interface

Connect the IEEE 1394 interface cable to the IEEE 1394 interface board.

- 1** Connect the IEEE 1394 interface cable to the IEEE 1394 port.

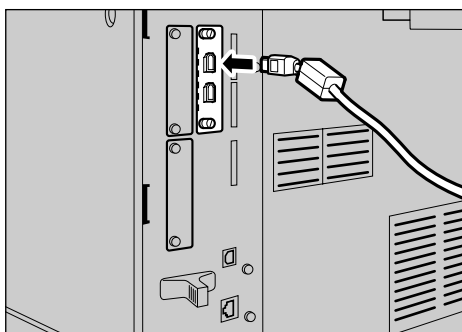

- 2** Connect the other end of the cable into the interface connector on the host computer.

Check the shape of the connector to the computer. Connect the cable firmly.

Note

- Use the interface cable supplied with the IEEE 1394 interface board.
- Two interface ports are available for connecting the IEEE 1394 interface cable. Either is suitable.
- For details about installing the printer driver, see "Preparing the Machine", Printer Reference.

Reference

"Turning On the Power", About This Machine

"Preparing the Machine", Printer Reference

Connecting to the IEEE 1284 Interface

Connect the IEEE 1284 interface cable to the IEEE 1284 interface board.

- 1** Make sure the main power switch on the machine is off.
If the main power switch is on, turn it off.
- 2** Turn off the main power switch of the host computer.
- 3** Connect the IEEE 1284 interface cable to the IEEE 1284 port.

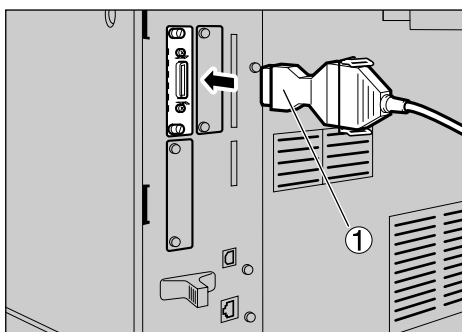

AMB015S

Use the conversion connector (1) supplied with the IEEE 1284 interface board.

- 4** Connect the other end of the cable into the interface connector on the host computer.
Check the shape of the connector to the computer. Connect the cable firmly.
- 5** Turn on the main power switch of the machine.
- 6** Turn on the host computer.

When using Windows 95/98/Me/2000/XP and Windows Server 2003, a printer driver installation screen might appear when the computer is turned on. If this happens, click **[Cancel]** on the screen.

Note

- For details about installing the printer driver, see "Preparing the Machine", Printer Reference.

Reference

"Turning On the Power", About This Machine

"Preparing the Machine", Printer Reference

Connecting to the IEEE 802.11b (Wireless LAN) Interface

Connect to the IEEE 802.11b (wireless LAN) interface.

1

Note

- Check the settings of the IPv4 address and subnet mask of this machine.
- For details about how to set the IPv4 address and subnet mask from the control panel of the machine, see "Interface Settings".

Reference

p.60 "Network"

Setup Procedure

Set up IEEE 802.11b (wireless LAN) according to the following procedure:

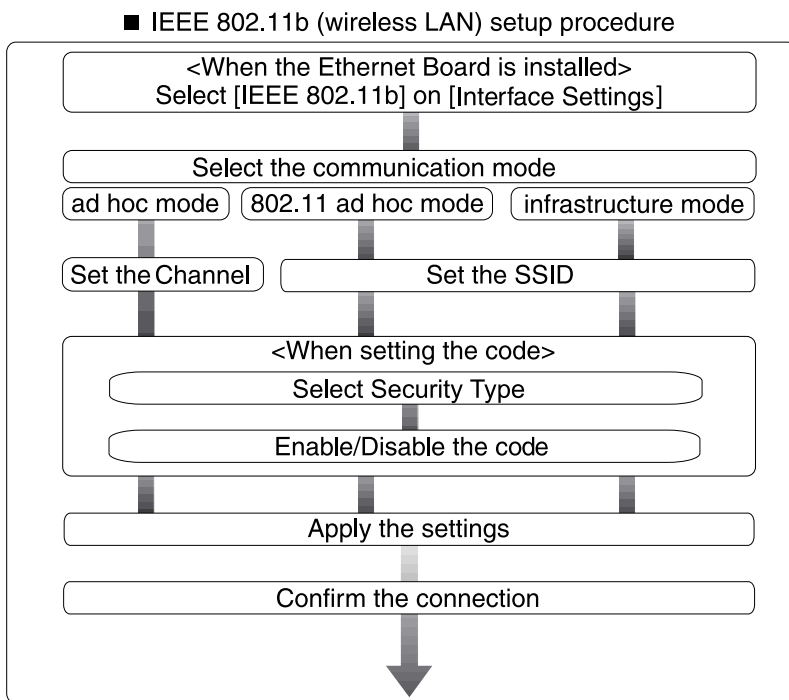

AME006S

Note

- Select **[802.11 Ad-hoc Mode]** mode when connecting Windows XP as a wireless LAN client using Windows XP standard driver or utilities, or when not using the infrastructure mode.
- For details about how to specify wireless LAN settings from the control panel on the machine, see "IEEE 802.11b".
- For details about how to specify wireless LAN settings from other than the control panel on the machine, see "Using Utilities to Make Settings".
- For details about the setting items, see "IEEE 802.11b".

Reference

p.67 "IEEE 802.11b"

p.38 "Using Utilities to Make Network Settings"

Checking the Connection

Check the wireless LAN connection.

Make sure the LED of the IEEE 802.11b interface unit is lit.

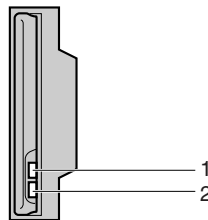
❖ When using in infrastructure mode

ZGDH600J

1. If [LAN Type] on the [Interface Settings] / [Network] screen is not set to [IEEE 802.11b], it does not light, even if the main power is on.

2. If it is connected properly to the network, the LED is green when in infrastructure mode. If the LED is blinking, the machine is searching for devices.

❖ When using in adhoc mode / 802.11 ad hoc mode

1

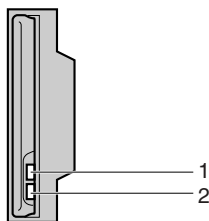

ZGDH600J

1. If the IEEE 802.11b interface unit is functioning, the LED lights up in orange.

2. If it is connected properly to the network, the LED is green when in ad hoc mode or 802.11 ad hoc mode. If the LED is blinking, the machine is searching for devices. The LED will light after a few seconds.

Print the configuration page to verify settings.

 **Note**

For more information about printing a configuration page, see "Print List".

 **Reference**

p.184 "Printing the configuration page"

Checking the Signal

When using in infrastructure mode, you can check the machine's radio wave status using the control panel.

- ① Press **[System Settings]**.
- ② Press **[Interface Settings]**.
- ③ Press **[IEEE 802.11b]**.
- ④ Press **[Wireless LAN Signal]**.
The machine's radio wave status appears.
- ⑤ After checking radio wave status, press **[Exit]**.
- ⑥ Press the **[User Tools/Counter]** key to return to the User Tools / Counter / Enquiry menu.

 **Note**

To check the radio wave status, press **[IEEE 802.11b]** under **[LAN Type]** in Network menu of Interface Settings.

 **Reference**

p.38 "Using Utilities to Make Network Settings"

p.67 "IEEE 802.11b"

Network Settings

This section describes the network settings you can change with User Tools (System Settings). Make settings according to functions you want to use and the interface to be connected.

Important

- These settings should be made by the system administrator, or with the advice the system administrator.

Settings Required to Use the Printer/LAN-Fax

This section lists the settings required for using the printer or LAN-Fax function.

Ethernet

This section lists the settings required for using the printer or LAN-Fax function with an Ethernet connection.

For details about how to specify the settings, see "Interface Settings".

Menu	User Tool	Setting Requirements
Interface Settings/Network	Machine IPv4 Address	Necessary
Interface Settings/Network	IPv4 Gateway Address	As required
Interface Settings/Network	Machine IPv6 Address	As required
Interface Settings/Network	IPv6 Gateway Address	As required
Interface Settings/Network	IPv6 Stateless Address Autoconfiguration	As required
Interface Settings/Network	DNS Configuration	As required
Interface Settings/Network	DDNS Configuration	As required
Interface Settings/Network	Domain Name	As required
Interface Settings/Network	WINS Configuration	As required
Interface Settings/Network	Effective Protocol	Necessary
Interface Settings/Network	NCP Delivery Protocol	As required
Interface Settings/Network	NW Frame Type	As required
Interface Settings/Network	SMB Computer Name	As required
Interface Settings/Network	SMB Work Group	As required
Interface Settings/Network	Ethernet Speed	As required
Interface Settings/Network	LAN Type	Necessary

Menu	User Tool	Setting Requirements
Interface Settings/Network	Permit SNMPv3 Communication	As required
Interface Settings/Network	Permit SSL/TLS Communication	As required
Interface Settings/Network	Host Name	As required
Interface Settings/Network	Machine Name	As required

Note

- IPv6 can be used only for the printer function.
- In **[Effective Protocol]**, check that the protocol you want to use is set to **[Active]**.
- [LAN Type]** is displayed when the wireless LAN board is installed. If Ethernet and IEEE 802.11b (wireless LAN) are both connected, the selected interface has priority.

Reference

p.60 "Interface Settings"

IEEE 1394 (IPv4 over 1394)

This section lists the settings required for using the printer or LAN-Fax function with IEEE 1394 interface cable.

For details about how to specify the settings, see "Interface Settings".

Menu	User Tool	Setting Requirements
Interface Settings/IEEE 1394	IPv4 Address	Necessary
Interface Settings/IEEE 1394	DDNS Configuration	As required
Interface Settings/IEEE 1394	Host Name	As required
Interface Settings/IEEE 1394	Domain Name	As required
Interface Settings/IEEE 1394	WINS Configuration	As required
Interface Settings/IEEE 1394	IPv4 over 1394	Necessary
Interface Settings/Network	IPv4 Gateway Address	As required
Interface Settings/Network	DNS Configuration	As required
Interface Settings/Network	Effective Protocol	Necessary

Note

- [IEEE 1394]** appears when IEEE 1394 interface board is installed.
- In **[Effective Protocol]**, check that the protocol you want to use is set to **[Active]**.

Reference

p.60 "Interface Settings"

IEEE 802.11b (wireless LAN)

This section lists the settings required for using the printer or LAN-Fax function with IEEE 802.11b (wireless LAN).

For details about how to specify the settings, see "Interface Settings".

Menu	User Tool	Setting Requirements
Interface Settings/Network	Machine IPv4 Address	Necessary
Interface Settings/Network	IPv4 Gateway Address	As required
Interface Settings/Network	Machine IPv6 Address	As required
Interface Settings/Network	IPv6 Gateway Address	As required
Interface Settings/Network	IPv6 Stateless Address Autoconfiguration	As required
Interface Settings/Network	DNS Configuration	As required
Interface Settings/Network	DDNS Configuration	As required
Interface Settings/Network	Domain Name	As required
Interface Settings/Network	WINS Configuration	As required
Interface Settings/Network	Effective Protocol	Necessary
Interface Settings/Network	NCP Delivery Protocol	As required
Interface Settings/Network	NW Frame Type	As required
Interface Settings/Network	SMB Computer Name	As required
Interface Settings/Network	SMB Work Group	As required
Interface Settings/Network	LAN Type	Necessary
Interface Settings/Network	Permit SNMPv3 Communication	As required
Interface Settings/Network	Permit SSL/TLS Communication	As required
Interface Settings/Network	Host Name	As required
Interface Settings/Network	Machine Name	As required
Interface Settings/IEEE 802.11b	Communication Mode	Necessary
Interface Settings/IEEE 802.11b	SSID Setting	As required
Interface Settings/IEEE 802.11b	Channel	As required
Interface Settings/IEEE 802.11b	Security Method	As required
Interface Settings/IEEE 802.11b	Transmission Speed	As required

Note

- In **[Effective Protocol]**, check that the protocol you want to use is set to **[Active]**.
- [IEEE 802.11b]** and **[LAN Type]** are displayed when the wireless LAN interface board is installed. If both Ethernet and wireless LAN (IEEE 802.11b) are connected, the selected interface takes precedence.

Reference

p.60 "Interface Settings"

Settings Required to Use Internet Fax

This section lists the settings required for using Internet Fax.

Ethernet

This section lists the settings required for using Internet Fax.

For details about how to specify the settings, see "Interface Settings" and "File Transfer".

Menu	User Tool	Setting Requirements
Interface Settings/Network	Machine IPv4 Address	Necessary
Interface Settings/Network	IPv4 Gateway Address	Necessary
Interface Settings/Network	DNS Configuration	As required
Interface Settings/Network	DDNS Configuration	As required
Interface Settings/Network	Domain Name	As required
Interface Settings/Network	WINS Configuration	As required
Interface Settings/Network	Effective Protocol	Necessary
Interface Settings/Network	Ethernet Speed	As required
Interface Settings/Network	LAN Type	Necessary
Interface Settings/Network	Permit SNMPv3 Communication	As required
Interface Settings/Network	Permit SSL/TLS Communication	As required
Interface Settings/Network	Host Name	As required
File Transfer	SMTP Server	Necessary
File Transfer	SMTP Authentication	As required
File Transfer	POP before SMTP	As required
File Transfer	Reception Protocol	As required
File Transfer	POP3 / IMAP4 Settings	As required
File Transfer	Administrator's E-mail Address	As required
File Transfer	E-mail Communication Port	Necessary
File Transfer	E-mail Reception Interval	As required
File Transfer	Max. Reception E-mail Size	As required
File Transfer	E-mail Storage in Server	As required
File Transfer	Program / Change / Delete E-mail Message	As required
File Transfer	Fax E-mail Account	Necessary

 **Note**

- In **[Effective Protocol]**, check that the protocol you want to use is set to **[Active]**.
- [LAN Type]** is displayed when the wireless LAN interface board is installed. If both Ethernet and wireless LAN (IEEE 802.11b) are connected, the selected interface takes precedence.
- [SMTP Server]** and **[Fax E-mail Account]** must be specified in order to use the send function.
- When **[POP before SMTP]** is set to **[On]**, also make setting for **[Reception Protocol]** and **[POP3 / IMAP4 Settings]**.
- When **[SMTP Authentication]** is set to **[On]**, also make setting for **[Administrator's E-mail Address]**.
- [E-mail Communication Port]** and **[Fax E-mail Account]** must be specified in order to use the reception function.
- When setting **[POP before SMTP]** to **[On]**, check **[POP3]** port number in **[E-mail Communication Port]**.

 **Reference**

p.60 "Interface Settings"

p.70 "File Transfer"

IEEE 1394 (IPv4 over 1394)

This section lists the settings required for using Internet Fax with IEEE 1394 interface cable

For details about how to specify the settings, see "Interface Settings" and "File Transfer".

Menu	User Tool	Setting Requirements
Interface Settings/IEEE 1394	IPv4 Address	Necessary
Interface Settings/IEEE 1394	DDNS Configuration	As required
Interface Settings/IEEE 1394	Host Name	As required
Interface Settings/IEEE 1394	Domain Name	As required
Interface Settings/IEEE 1394	WINS Configuration	As required
Interface Settings/IEEE 1394	IPv4 over 1394	Necessary
Interface Settings/Network	IPv4 Gateway Address	Necessary
Interface Settings/Network	DNS Configuration	As required
Interface Settings/Network	Effective Protocol	Necessary
File Transfer	SMTP Server	Necessary
File Transfer	SMTP Authentication	As required
File Transfer	POP before SMTP	As required
File Transfer	Reception Protocol	As required
File Transfer	POP3 / IMAP4 Settings	As required

Menu	User Tool	Setting Requirements
File Transfer	Administrator's E-mail Address	As required
File Transfer	E-mail Communication Port	Necessary
File Transfer	E-mail Reception Interval	As required
File Transfer	Max. Reception E-mail Size	As required
File Transfer	E-mail Storage in Server	As required
File Transfer	Program / Change / Delete E-mail Message	As required
File Transfer	Fax E-mail Account	Necessary

Note

- [IEEE 1394] is displayed when the IEEE 1394 interface board is installed.
- In [Effective Protocol], check that the protocol you want to use is set to [Active].
- [SMTP Server] and [Fax E-mail Account] must be specified in order to use the send function.
- When [POP before SMTP] is set to [On], also make setting for [Reception Protocol] and [POP3 / IMAP4 Settings].
- When [SMTP Authentication] is set to [On], also make setting for [Administrator's E-mail Address].
- [E-mail Communication Port] and [Fax E-mail Account] must be specified in order to use the reception function.
- When setting [POP before SMTP] to [On], check [POP3] port number in [E-mail Communication Port].

Reference

p.60 "Interface Settings"

p.70 "File Transfer"

IEEE 802.11b (wireless LAN)

This section lists the settings required for using Internet Fax with IEEE 802.11b (wireless LAN).

For details about how to specify the settings, see "Interface Settings" and "File Transfer".

Menu	User Tool	Setting Requirements
Interface Settings/Network	Machine IPv4 Address	Necessary
Interface Settings/Network	IPv4 Gateway Address	Necessary
Interface Settings/Network	DNS Configuration	As required
Interface Settings/Network	DDNS Configuration	As required
Interface Settings/Network	Domain Name	As required
Interface Settings/Network	WINS Configuration	As required
Interface Settings/Network	Effective Protocol	Necessary
Interface Settings/Network	LAN Type	Necessary
Interface Settings/Network	Permit SNMPv3 Communication	As required
Interface Settings/Network	Permit SSL/TLS Communication	As required
Interface Settings/Network	Host Name	As required
Interface Settings/IEEE 802.11b	Communication Mode	Necessary
Interface Settings/IEEE 802.11b	SSID Setting	As required
Interface Settings/IEEE 802.11b	Channel	As required
Interface Settings/IEEE 802.11b	Security Method	As required
Interface Settings/IEEE 802.11b	Transmission Speed	As required
File Transfer	SMTP Server	Necessary
File Transfer	SMTP Authentication	As required
File Transfer	POP before SMTP	As required
File Transfer	Reception Protocol	As required
File Transfer	POP3 / IMAP4 Settings	As required
File Transfer	Administrator's E-mail Address	As required
File Transfer	E-mail Communication Port	Necessary
File Transfer	E-mail Reception Interval	As required
File Transfer	Max. Reception E-mail Size	As required
File Transfer	E-mail Storage in Server	As required
File Transfer	Program / Change / Delete E-mail Message	As required
File Transfer	Fax E-mail Account	Necessary

Note

- In **[Effective Protocol]**, check that the protocol you want to use is set to **[Active]**.
- [IEEE 802.11b]** and **[LAN Type]** are displayed when the wireless LAN interface board is installed. If both Ethernet and wireless LAN (IEEE 802.11b) are connected, the selected interface takes precedence.
- [SMTP Server]** and **[Fax E-mail Account]** must be specified in order to use the send function.
- When **[POP before SMTP]** is set to **[On]**, also make setting for **[Reception Protocol]** and **[POP3 / IMAP4 Settings]**.
- When **[SMTP Authentication]** is set to **[On]**, also make setting for **[Administrator's E-mail Address]**.
- [E-mail Communication Port]** and **[Fax E-mail Account]** must be specified in order to use the reception function.
- When setting **[POP before SMTP]** to **[On]**, check **[POP3]** port number in **[E-mail Communication Port]**.

Reference

p.60 "Interface Settings"

p.70 "File Transfer"

Settings Required to Use E-mail Function

This section lists the settings required for sending e-mail.

Ethernet

This section lists the settings required for sending e-mail with Ethernet cable. For details about how to specify the settings, see "Interface Settings" and "File Transfer".

Menu	User Tool	Setting Requirements
Interface Settings/Network	Machine IPv4 Address	Necessary
Interface Settings/Network	IPv4 Gateway Address	Necessary
Interface Settings/Network	DNS Configuration	As required
Interface Settings/Network	DDNS Configuration	As required
Interface Settings/Network	Domain Name	As required
Interface Settings/Network	WINS Configuration	As required
Interface Settings/Network	Effective Protocol	Necessary
Interface Settings/Network	Ethernet Speed	As required
Interface Settings/Network	LAN Type	Necessary
Interface Settings/Network	Permit SNMPv3 Communication	As required

Menu	User Tool	Setting Requirements
Interface Settings/Network	Permit SNMPv3 Communication	As required
Interface Settings/Network	Host Name	As required
File Transfer	SMTP Server	Neccessary
File Transfer	SMTP Authentication	As required
File Transfer	POP before SMTP	As required
File Transfer	Reception Protocol	As required
File Transfer	POP3 / IMAP4 Settings	As required
File Transfer	Administrator's E-mail Address	As required
File Transfer	E-mail Communication Port	As required
File Transfer	Program / Change / Delete E-mail Message	As required
File Transfer	Scanner Resend Interval Time	As required
File Transfer	Number of Scanner Resends	As required

Note

- In **[Effective Protocol]**, check that the protocol you want to use is set to **[Active]**.
- [LAN Type]** is displayed when the wireless LAN interface board is installed. If both ethernet and wireless LAN (IEEE 802.11b) are connected, the selected interface takes precedence.
- When **[POP before SMTP]** is set to **[On]**, also make setting for **[Reception Protocol]** and **[POP3 / IMAP4 Settings]**.
- When setting **[POP before SMTP]** to **[On]**, check **[POP3]** port number in **[E-mail Communication Port]**.

Reference

p.60 "Interface Settings"

p.70 "File Transfer"

IEEE 1394 (IPv4 over 1394)

This section lists the settings required for sending e-mail with IEEE 1394 interface cable.

For details about how to specify the settings, see "Interface Settings" and "File Transfer".

Menu	User Tool	Setting Requirements
Interface Settings/IEEE 1394	IPv4 Address	Necessary
Interface Settings/IEEE 1394	DDNS Configuration	As required
Interface Settings/IEEE 1394	Host Name	As required
Interface Settings/IEEE 1394	Domain Name	As required
Interface Settings/IEEE 1394	WINS Configuration	As required
Interface Settings/IEEE 1394	IPv4 over 1394	Necessary
Interface Settings/Network	IPv4 Gateway Address	Necessary
Interface Settings/Network	DNS Configuration	As required
Interface Settings/Network	Effective Protocol	Necessary
File Transfer	SMTP Server	Necessary
File Transfer	SMTP Authentication	As required
File Transfer	POP before SMTP	As required
File Transfer	Reception Protocol	As required
File Transfer	POP3 / IMAP4 Settings	As required
File Transfer	Administrator's E-mail Address	As required
File Transfer	E-mail Communication Port	As required
File Transfer	Program / Change / Delete E-mail Message	As required
File Transfer	Scanner Resend Interval Time	As required
File Transfer	Number of Scanner Resends	As required

Note

- [IEEE 1394]** is displayed when the IEEE 1394 interface board is installed.
- In **[Effective Protocol]**, check that the protocol you want to use is set to **[Active]**.
- When **[POP before SMTP]** is set to **[On]**, also make setting for **[Reception Protocol]** and **[POP3 / IMAP4 Settings]**.
- When setting **[POP before SMTP]** to **[On]**, check **[POP3]** port number in **[E-mail Communication Port]**.

Reference

p.60 "Interface Settings"

p.70 "File Transfer"

IEEE 802.11b (wireless LAN)

This section lists the settings required for sending e-mail with IEEE 802.11b (wireless LAN).

For details about how to specify the settings, see "Interface Settings" and "File Transfer".

Menu	User Tool	Setting Requirements
Interface Settings/Network	Machine IPv4 Address	Necessary
Interface Settings/Network	IPv4 Gateway Address	Necessary
Interface Settings/Network	DNS Configuration	As required
Interface Settings/Network	DDNS Configuration	As required
Interface Settings/Network	Domain Name	As required
Interface Settings/Network	WINS Configuration	As required
Interface Settings/Network	Effective Protocol	Necessary
Interface Settings/Network	LAN Type	Necessary
Interface Settings/Network	Permit SNMPv3 Communication	As required
Interface Settings/Network	Permit SSL/TLS Communication	As required
Interface Settings/Network	Host Name	As required
Interface Settings/IEEE 802.11b	Communication Mode	Necessary
Interface Settings/IEEE 802.11b	SSID Setting	As required
Interface Settings/IEEE 802.11b	Channel	As required
Interface Settings/IEEE 802.11b	Security Method	As required
Interface Settings/IEEE 802.11b	Transmission Speed	As required
File Transfer	SMTP Server	Necessary
File Transfer	SMTP Authentication	As required
File Transfer	POP before SMTP	As required
File Transfer	Reception Protocol	As required
File Transfer	POP3 / IMAP4 Settings	As required
File Transfer	Administrator's E-mail Address	As required
File Transfer	E-mail Communication Port	As required
File Transfer	Program / Change / Delete E-mail Message	As required
File Transfer	Scanner Resend Interval Time	As required
File Transfer	Number of Scanner Resends	As required

 **Note**

- In **[Effective Protocol]**, check that the protocol you want to use is set to **[Active]**.
- [LAN Type]** is displayed when the wireless LAN interface board is installed. If both ethernet and wireless LAN (IEEE 802.11b) are connected, the selected interface takes precedence.
- When **[POP before SMTP]** is set to **[On]**, also make setting for **[Reception Protocol]** and **[POP3 / IMAP4 Settings]**.
- When setting **[POP before SMTP]** to **[On]**, check **[POP3]** port number in **[E-mail Communication Port]**.

 **Reference**

p.60 "Interface Settings"

p.70 "File Transfer"

Settings Required to Use Scan to Folder Function

This section lists the settings required for sending file.

Ethernet

This section lists the settings required for sending file with ethernet cable.

For details about how to specify the settings, see "Interface Settings" and "File Transfer".

Menu	User Tool	Setting Requirements
Interface Settings/Network	Machine IPv4 Address	Necessary
Interface Settings/Network	IPv4 Gateway Address	Necessary
Interface Settings/Network	DNS Configuration	As required
Interface Settings/Network	DDNS Configuration	As required
Interface Settings/Network	Domain Name	As required
Interface Settings/Network	WINS Configuration	As required
Interface Settings/Network	Effective Protocol	Necessary
Interface Settings/Network	Ethernet Speed	As required
Interface Settings/Network	LAN Type	Necessary
Interface Settings/Network	Permit SNMPv3 Communication	As required
Interface Settings/Network	Permit SSL/TLS Communication	As required
Interface Settings/Network	Host Name	As required
File Transfer	Scanner Resend Interval Time	As required
File Transfer	Number of Scanner Resends	As required

 **Note**

- In **[Effective Protocol]**, check that the protocol you want to use is set to **[Active]**.
- [LAN Type]** is displayed when the wireless LAN interface board is installed. If both ethernet and wireless LAN (IEEE 802.11b) are connected, the selected interface takes precedence.

 **Reference**

p.60 "Interface Settings"

p.70 "File Transfer"

IEEE 1394 (IPv4 over 1394)

This section lists the settings required for sending file with IEEE 1394 interface cable.

For details about how to specify the settings, see "Interface Settings" and "File Transfer".

Menu	User Tool	Setting Requirements
Interface Settings/IEEE 1394	IPv4 Address	Necessary
Interface Settings/IEEE 1394	DDNS Configuration	As required
Interface Settings/IEEE 1394	Host Name	As required
Interface Settings/IEEE 1394	Domain Name	As required
Interface Settings/IEEE 1394	WINS Configuration	As required
Interface Settings/IEEE 1394	IPv4 over 1394	Necessary
Interface Settings/Network	IPv4 Gateway Address	Necessary
Interface Settings/Network	DNS Configuration	As required
Interface Settings/Network	Effective Protocol	Necessary
File Transfer	Scanner Resend Interval Time	As required
File Transfer	Number of Scanner Resends	As required

 **Note**

- [IEEE 1394]** is displayed when the IEEE 1394 interface board is installed.
- In **[Effective Protocol]**, check that the protocol you want to use is set to **[Active]**.

 **Reference**

p.60 "Interface Settings"

p.70 "File Transfer"

IEEE 802.11b (wireless LAN)

This section lists the settings required for sending file with IEEE 802.11b (wireless LAN).

For details about how to specify the settings, see "Interface Settings" and "File Transfer".

Menu	User Tool	Setting Requirements
Interface Settings/Network	Machine IPv4 Address	Necessary
Interface Settings/Network	IPv4 Gateway Address	Necessary
Interface Settings/Network	DNS Configuration	As required
Interface Settings/Network	DDNS Configuration	As required
Interface Settings/Network	Domain Name	As required
Interface Settings/Network	WINS Configuration	As required
Interface Settings/Network	Effective Protocol	Necessary
Interface Settings/Network	LAN Type	Necessary
Interface Settings/Network	Permit SNMPv3 Communication	As required
Interface Settings/Network	Permit SSL/TLS Communication	As required
Interface Settings/Network	Host Name	As required
Interface Settings/IEEE 802.11b	Communication Mode	Necessary
Interface Settings/IEEE 802.11b	SSID Setting	As required
Interface Settings/IEEE 802.11b	Channel	As required
Interface Settings/IEEE 802.11b	Security Method	As required
Interface Settings/IEEE 802.11b	Transmission Speed	As required
File Transfer	Scanner Resend Interval Time	As required
File Transfer	Number of Scanner Resends	As required

Note

- In **[Effective Protocol]**, check that the protocol you want to use is set to **[Active]**.
- [IEEE 802.11b]** and **[LAN Type]** are displayed when the wireless LAN interface board is installed. If both ethernet and wireless LAN (IEEE 802.11b) are connected, the selected interface takes precedence.

Reference

- p.60 "Interface Settings"
- p.70 "File Transfer"

Settings Required to Use the Network Delivery Scanner

This section lists the settings required for delivering data to network.

Ethernet

This section lists the settings required for delivering data to network with ethernet cable.

For details about how to specify the settings, see "Interface Settings" and "File Transfer".

Menu	User Tool	Setting Requirements
Interface Settings/Network	Machine IPv4 Address	Necessary
Interface Settings/Network	IPv4 Gateway Address	As required
Interface Settings/Network	DNS Configuration	As required
Interface Settings/Network	DDNS Configuration	As required
Interface Settings/Network	Domain Name	As required
Interface Settings/Network	WINS Configuration	As required
Interface Settings/Network	Effective Protocol	Necessary
Interface Settings/Network	Ethernet Speed	As required
Interface Settings/Network	LAN Type	Necessary
Interface Settings/Network	Permit SNMPv3 Communication	As required
Interface Settings/Network	Permit SSL/TLS Communication	As required
Interface Settings/Network	Host Name	As required
File Transfer	Delivery Option	As required
File Transfer	Fax RX File Transmission	As required
File Transfer	Scanner Resend Interval Time	As required
File Transfer	Number of Scanner Resends	As required

Note

- In **[Effective Protocol]**, check that the protocol you want to use is set to **[Active]**.
- [LAN Type]** is displayed when the wireless LAN interface board is installed. When both ethernet and wireless LAN (IEEE 802.11b) are connected, the selected interface takes precedence.
- If **[Delivery Option]** is set to **[On]**, check that IPv4 Address is set.

Reference

- p.60 "Interface Settings"
- p.70 "File Transfer"

IEEE 1394 (IPv4 over 1394)

This section lists the settings required for delivering data to network with IEEE 1394 interface cable.

For details about how to specify the settings, see "Interface Settings" and "File Transfer".

Menu	User Tool	Setting Requirements
Interface Settings/IEEE 1394	IPv4 Address	Necessary
Interface Settings/IEEE 1394	DDNS Configuration	As required
Interface Settings/IEEE 1394	Host Name	As required
Interface Settings/IEEE 1394	Domain Name	As required
Interface Settings/IEEE 1394	WINS Configuration	As required
Interface Settings/IEEE 1394	IPv4 over 1394	Necessary
Interface Settings/Network	IPv4 Gateway Address	As required
Interface Settings/Network	DNS Configuration	As required
Interface Settings/Network	Effective Protocol	Necessary
File Transfer	Delivery Option	As required
File Transfer	Fax RX File Transmission	As required
File Transfer	Scanner Resend Interval Time	As required
File Transfer	Number of Scanner Resends	As required

Note

- [IEEE 1394]** is displayed when the IEEE 1394 interface board is installed.
- In **[Effective Protocol]**, check that the protocol you want to use is set to **[Active]**.
- If **[Delivery Option]** is set to **[On]**, check that IPv4 Address is set.

Reference

p.60 "Interface Settings"

p.70 "File Transfer"

IEEE 802.11b (wireless LAN)

This section lists the settings required for delivering data to network with IEEE 802.11b (wireless LAN).

For details about how to specify the settings, see "Interface Settings" and "File Transfer".

Menu	User Tool	Setting Requirements
Interface Settings/Network	Machine IPv4 Address	Necessary
Interface Settings/Network	IPv4 Gateway Address	As required
Interface Settings/Network	DNS Configuration	As required
Interface Settings/Network	DDNS Configuration	As required
Interface Settings/Network	Domain Name	As required
Interface Settings/Network	WINS Configuration	As required
Interface Settings/Network	Effective Protocol	Necessary
Interface Settings/Network	LAN Type	Necessary
Interface Settings/Network	Permit SNMPv3 Communication	As required
Interface Settings/Network	Permit SSL/TLS Communication	As required
Interface Settings/Network	Host Name	As required
Interface Settings/IEEE 802.11b	Communication Mode	Necessary
Interface Settings/IEEE 802.11b	SSID Setting	As required
Interface Settings/IEEE 802.11b	Channel	As required
Interface Settings/IEEE 802.11b	Security Method	As required
Interface Settings/IEEE 802.11b	Transmission Speed	As required
File Transfer	Delivery Option	As required
File Transfer	Fax RX File Transmission	As required
File Transfer	Scanner Resend Interval Time	As required
File Transfer	Number of Scanner Resends	As required

Note

- In **[Effective Protocol]**, check that the protocol you want to use is set to **[Active]**.
- [IEEE 802.11b]** and **[LAN Type]** are displayed when the wireless LAN interface board is installed. When both Ethernet and wireless LAN (IEEE 802.11b) are connected, the selected interface takes precedence.
- If **[Delivery Option]** is set to **[On]**, check that IPv4 Address is set.

Reference

- p.60 "Interface Settings"
- p.70 "File Transfer"

Settings Required to Use Network TWAIN Scanner

This section lists the settings required for using TWAIN Scanner under the network environment.

Ethernet

This section lists the settings required for using network TWAIN Scanner with Ethernet cable.

For details about how to specify the settings, see "Interface Settings".

Menu	User Tool	Setting Requirements
Interface Settings/Network	Machine IPv4 Address	Necessary
Interface Settings/Network	IPv4 Gateway Address	As required
Interface Settings/Network	DNS Configuration	As required
Interface Settings/Network	DDNS Configuration	As required
Interface Settings/Network	Domain Name	As required
Interface Settings/Network	WINS Configuration	As required
Interface Settings/Network	Effective Protocol	Necessary
Interface Settings/Network	LAN Type	Necessary
Interface Settings/Network	Ethernet Speed	As required
Interface Settings/Network	Permit SNMPv3 Communication	As required
Interface Settings/Network	Permit SSL/TLS Communication	As required
Interface Settings/Network	Host Name	As required

Note

- In **[Effective Protocol]**, check that the protocol you want to use is set to **[Active]**.
- [LAN Type]** is displayed when the wireless LAN interface board is installed. When both Ethernet and wireless LAN (IEEE 802.11b) are connected, the selected interface takes precedence.

Reference

p.60 "Interface Settings"

IEEE 1394 (IPv4 over 1394)

This section lists the settings required for using network TWAIN Scanner with IEEE 1394 interface cable.

For details about how to specify the settings, see "Interface Settings" and "File Transfer".

Menu	User Tool	Setting Requirements
Interface Settings/IEEE 1394	IPv4 Address	Necessary
Interface Settings/IEEE 1394	DDNS Configuration	As required
Interface Settings/IEEE 1394	Host Name	As required
Interface Settings/IEEE 1394	Domain Name	As required
Interface Settings/IEEE 1394	WINS Configuration	As required
Interface Settings/IEEE 1394	IPv4 over 1394	Necessary
Interface Settings/Network	IPv4 Gateway Address	As required
Interface Settings/Network	DNS Configuration	As required
Interface Settings/Network	Effective Protocol	Necessary

Note

- [IEEE 1394]** is displayed when the IEEE 1394 interface board is installed.
- In **[Effective Protocol]**, check that the protocol you want to use is set to **[Active]**.

Reference

p.60 "Interface Settings"

IEEE 802.11b (wireless LAN)

This section lists the settings required for using network TWAIN Scanner with IEEE 802.11b (wireless LAN).

For details about how to specify the settings, see "Interface Settings".

Menu	User Tool	Setting Requirements
Interface Settings/Network	Machine IPv4 Address	Necessary
Interface Settings/Network	IPv4 Gateway Address	As required
Interface Settings/Network	DNS Configuration	As required
Interface Settings/Network	DDNS Configuration	As required
Interface Settings/Network	Domain Name	As required
Interface Settings/Network	WINS Configuration	As required
Interface Settings/Network	Effective Protocol	Necessary
Interface Settings/Network	LAN Type	Necessary
Interface Settings/Network	Permit SNMPv3 Communication	As required
Interface Settings/Network	Permit SSL/TLS Communication	As required
Interface Settings/Network	Host Name	As required
Interface Settings/IEEE 802.11b	Communication Mode	Necessary
Interface Settings/IEEE 802.11b	SSID Setting	As required
Interface Settings/IEEE 802.11b	Channel	As required
Interface Settings/IEEE 802.11b	Security Method	As required
Interface Settings/IEEE 802.11b	Transmission Speed	As required

Note

- In **[Effective Protocol]**, check that the protocol you want to use is set to **[Active]**.
- [IEEE 802.11b]** and **[LAN Type]** are displayed when the wireless LAN interface board is installed. When both Ethernet and wireless LAN (IEEE 802.11b) are connected, the selected interface takes precedence.

Reference

p.60 "Interface Settings"

Settings Required to Use Document Server

This section lists the settings required for using Document Server function under the network environment.

Ethernet

This section lists the settings required for using Document Server function with Ethernet cable.

For details about how to specify the settings, see "Interface Settings".

Menu	User Tool	Setting Requirements
Interface Settings/Network	Machine IPv4 Address	Necessary
Interface Settings/Network	IPv4 Gateway Address	As required
Interface Settings/Network	DNS Configuration	As required
Interface Settings/Network	DDNS Configuration	As required
Interface Settings/Network	Domain Name	As required
Interface Settings/Network	WINS Configuration	As required
Interface Settings/Network	Effective Protocol	Necessary
Interface Settings/Network	Ethernet Speed	As required
Interface Settings/Network	LAN Type	Necessary
Interface Settings/Network	Permit SNMPv3 Communication	As required
Interface Settings/Network	Permit SSL/TLS Communication	As required
Interface Settings/Network	Host Name	As required

Note

- In **[Effective Protocol]**, check that the protocol you want to use is set to **[Active]**.
- [LAN Type]** is displayed when the wireless LAN interface board is installed. When both Ethernet and wireless LAN (IEEE 802.11b) are connected, the selected interface takes precedence.

Reference

p.60 "Interface Settings"

IEEE 1394 (IPv4 over 1394)

This section lists the settings required for using Document Server function with IEEE 1394 interface cable.

For details about how to specify the settings, see "Interface Settings".

Menu	User Tool	Setting Requirements
Interface Settings/IEEE 1394	IPv4 Address	Necessary
Interface Settings/IEEE 1394	DDNS Configuration	As required
Interface Settings/IEEE 1394	Host Name	As required
Interface Settings/IEEE 1394	Domain Name	As required
Interface Settings/IEEE 1394	WINS Configuration	As required
Interface Settings/IEEE 1394	IPv4 over 1394	Necessary
Interface Settings/Network	IPv4 Gateway Address	As required
Interface Settings/Network	DNS Configuration	As required
Interface Settings/Network	Effective Protocol	Necessary

Note

- [IEEE 1394]** is displayed when the IEEE 1394 interface board is installed.
- In **[Effective Protocol]**, check that the protocol you want to use is set to **[Active]**.

Reference

p.60 "Interface Settings"

IEEE 802.11b (wireless LAN)

This section lists the settings required for using Document Server function with IEEE 802.11b (wireless LAN).

For details about how to specify the settings, see "Interface Settings".

Menu	User Tool	Setting Requirements
Interface Settings/Network	Machine IPv4 Address	Neccessary
Interface Settings/Network	IPv4 Gateway Address	As required
Interface Settings/Network	DNS Configuration	As required
Interface Settings/Network	DDNS Configuration	As required
Interface Settings/Network	Domain Name	As required
Interface Settings/Network	WINS Configuration	As required
Interface Settings/Network	Effective Protocol	Neccessary
Interface Settings/Network	LAN Type	As required/Neccessary
Interface Settings/Network	Permit SNMPv3 Communication	As required
Interface Settings/Network	Permit SSL/TLS Communication	As required
Interface Settings/Network	Host Name	As required
Interface Settings/IEEE 802.11b	Communication Mode	Neccessary
Interface Settings/IEEE 802.11b	SSID Setting	As required
Interface Settings/IEEE 802.11b	Channel	As required
Interface Settings/IEEE 802.11b	Security Method	As required
Interface Settings/IEEE 802.11b	Transmission Speed	As required

Note

- In **[Effective Protocol]**, check that the protocol you want to use is set to **[Active]**.
- [IEEE 802.11b]** and **[LAN Type]** are displayed when the wireless LAN interface board is installed. When both Ethernet and wireless LAN (IEEE 802.11b) are connected, the selected interface takes precedence.

Reference

p.60 "Interface Settings"

Using Utilities to Make Network Settings

You can also specify network settings using utilities such as Web Image Monitor, SmartDeviceMonitor for Admin, and telnet.

Note

- For details about using Web Image Monitor, see "Using Web Image Monitor", Network Guide.
- For details about using SmartDeviceMonitor for Admin, see "Using SmartDeviceMonitor for Admin", Network Guide.
- For Details about using telnet, see "Remote Maintenance", Network Guide.

Reference

"Using Web Image Monitor", Network Guide

"Using SmartDeviceMonitor for Admin", Network Guide

"Remote Maintenance by telnet", Network Guide

Interface Settings

Change settings by using Web Image Monitor, SmartDeviceMonitor for Admin, and telnet.

- ❖ **[Network] → [Machine IPv4 Address] → [Auto-Obtain (DHCP)]**
 - Web Image Monitor:Can be used for specifying the setting.
 - SmartDeviceMonitor for Admin:Can be used for specifying the setting.
 - telnet:Can be used for specifying the setting.
- ❖ **[Network] → [Machine IPv4 Address] → [Specify] → [IPv4 Address]**
 - Web Image Monitor:Can be used for specifying the setting.
 - SmartDeviceMonitor for Admin:Can be used for specifying the setting.
 - telnet:Can be used for specifying the setting.
- ❖ **[Network] → [Machine IPv4 Address] → [Specify] → [Sub-net Mask]**
 - Web Image Monitor:Can be used for specifying the setting.
 - SmartDeviceMonitor for Admin:Can be used for specifying the setting.
 - telnet:Can be used for specifying the setting.
- ❖ **[Network] → [IPv4 Gateway Address]**
 - Web Image Monitor:Can be used for specifying the setting.
 - SmartDeviceMonitor for Admin:Can be used for specifying the setting.
 - telnet:Can be used for specifying the setting.

- ❖ **[Network] → [Machine IPv6 Address] → [Manual Configuration Address]**
 - Web Image Monitor:Can be used for specifying the setting.
 - SmartDeviceMonitor for Admin:Cannot be used for specifying the setting.
 - telnet:Can be used for specifying the setting.
- ❖ **[Network] → [IPv6 Stateless Address Autoconfiguration]**
 - Web Image Monitor:Can be used for specifying the setting.
 - SmartDeviceMonitor for Admin:Cannot be used for specifying the setting.
 - telnet:Can be used for specifying the setting.
- ❖ **[Network] → [DNS Configuration] → [Auto-Obtain (DHCP)]**
 - Web Image Monitor:Can be used for specifying the setting.
 - SmartDeviceMonitor for Admin:Cannot be used for specifying the setting.
 - telnet:Can be used for specifying the setting.
- ❖ **[Network] → [DNS Configuration] → [Specify] → [DNS Server 1-3]**
 - Web Image Monitor:Can be used for specifying the setting.
 - SmartDeviceMonitor for Admin:Cannot be used for specifying the setting.
 - telnet:Can be used for specifying the setting.
- ❖ **[Network] → [DDNS Configuration]**
 - Web Image Monitor:Can be used for specifying the setting.
 - SmartDeviceMonitor for Admin:Cannot be used for specifying the setting.
 - telnet:Can be used for specifying the setting.
- ❖ **[Network] → [Domain Name] → [Auto-Obtain (DHCP)]**
 - Web Image Monitor:Can be used for specifying the setting.
 - SmartDeviceMonitor for Admin:Cannot be used for specifying the setting.
 - telnet:Can be used for specifying the setting.
- ❖ **[Network] → [Domain Name] → [Specify] → [Domain Name]**
 - Web Image Monitor:Can be used for specifying the setting.
 - SmartDeviceMonitor for Admin:Cannot be used for specifying the setting.
 - telnet:Can be used for specifying the setting.
- ❖ **[Network] → [WINS Configuration] → [On] → [Primary WINS Server]**
 - Web Image Monitor:Can be used for specifying the setting.
 - SmartDeviceMonitor for Admin:Cannot be used for specifying the setting.
 - telnet:Can be used for specifying the setting.

- ❖ **[Network] → [WINS Configuration] → [On] → [Secondary WINS Server]**
 - Web Image Monitor: Can be used for specifying the setting.
 - SmartDeviceMonitor for Admin: Cannot be used for specifying the setting.
 - telnet: Can be used for specifying the setting.
- ❖ **[Network] → [WINS Configuration] → [On] → [Scope ID]**
 - Web Image Monitor: Can be used for specifying the setting.
 - SmartDeviceMonitor for Admin: Cannot be used for specifying the setting.
 - telnet: Can be used for specifying the setting.
- ❖ **[Network] → [Effective Protocol] → [IPv4]**
 - Web Image Monitor: Can be used for specifying the setting.
 - SmartDeviceMonitor for Admin: You can make the TCP/IP settings if SmartDeviceMonitor for Admin is communicating with the machine using IPX/SPX.
 - telnet: Can be used for specifying the setting.
- ❖ **[Network] → [Effective Protocol] → [IPv6]**
 - Web Image Monitor: Can be used for specifying the setting.
 - SmartDeviceMonitor for Admin: Can be used for specifying the setting.
 - telnet: Can be used for specifying the setting.
- ❖ **[Network] → [Effective Protocol] → [NetWare]**
 - Web Image Monitor: Can be used for specifying the setting.
 - SmartDeviceMonitor for Admin: You can make the IPX/SPX settings if SmartDeviceMonitor for Admin is communicating with the machine using TCP/IP.
 - telnet: Can be used for specifying the setting.
- ❖ **[Network] → [Effective Protocol] → [SMB]**
 - Web Image Monitor: Can be used for specifying the setting.
 - SmartDeviceMonitor for Admin: Can be used for specifying the setting.
 - telnet: Can be used for specifying the setting.
- ❖ **[Network] → [Effective Protocol] → [AppleTalk]**
 - Web Image Monitor: Can be used for specifying the setting.
 - SmartDeviceMonitor for Admin: Can be used for specifying the setting.
 - telnet: Can be used for specifying the setting.

❖ [Network] → [NCP Delivery Protocol]

- Web Image Monitor:Can be used for specifying the setting.
- SmartDeviceMonitor for Admin:Can be used for specifying the setting.
- telnet:Cannot be used for specifying the setting.

❖ [Network] → [NW Frame Type] → [Auto Select]

- Web Image Monitor:Can be used for specifying the setting.
- SmartDeviceMonitor for Admin:Cannot be used for specifying the setting.
- telnet:Can be used for specifying the setting.

❖ [Network] → [NW Frame Type] → [Ethernet II]

- Web Image Monitor:Can be used for specifying the setting.
- SmartDeviceMonitor for Admin:Cannot be used for specifying the setting.
- telnet:Can be used for specifying the setting.

❖ [Network] → [NW Frame Type] → [Ethernet 802.2]

- Web Image Monitor:Can be used for specifying the setting.
- SmartDeviceMonitor for Admin:Cannot be used for specifying the setting.
- telnet:Can be used for specifying the setting.

❖ [Network] → [NW Frame Type] → [Ethernet 802.3]

- Web Image Monitor:Can be used for specifying the setting.
- SmartDeviceMonitor for Admin:Cannot be used for specifying the setting.
- telnet:Can be used for specifying the setting.

❖ [Network] → [NW Frame Type] → [Ethernet SNAP]

- Web Image Monitor:Can be used for specifying the setting.
- SmartDeviceMonitor for Admin:Cannot be used for specifying the setting.
- telnet:Can be used for specifying the setting.

❖ [Network] → [SMB Computer Name]

- Web Image Monitor:Can be used for specifying the setting.
- SmartDeviceMonitor for Admin:Cannot be used for specifying the setting.
- telnet:Can be used for specifying the setting.

❖ [Network] → [SMB Work Group]

- Web Image Monitor:Can be used for specifying the setting.
- SmartDeviceMonitor for Admin:Cannot be used for specifying the setting.
- telnet:Can be used for specifying the setting.

❖ **[Network] → [Ethernet Speed]**

- Web Image Monitor:Cannot be used for specifying the setting.
- SmartDeviceMonitor for Admin:Cannot be used for specifying the setting.
- telnet:Cannot be used for specifying the setting.

❖ **[Network] → [LAN Type] → [Ethernet]**

- Web Image Monitor:Can be used for specifying the setting.
- SmartDeviceMonitor for Admin:Cannot be used for specifying the setting.
- telnet:Can be used for specifying the setting.

❖ **[Network] → [LAN Type] → [IEEE 802.11b]**

- Web Image Monitor:Can be used for specifying the setting.
- SmartDeviceMonitor for Admin:Cannot be used for specifying the setting.
- telnet:Can be used for specifying the setting.

❖ **[Network] → [Host Name]**

- Web Image Monitor:Can be used for specifying the setting.
- SmartDeviceMonitor for Admin:Can be used for specifying the setting.
- telnet:Can be used for specifying the setting.

❖ **[Network] → [Machine Name]**

- Web Image Monitor:Can be used for specifying the setting.
- SmartDeviceMonitor for Admin:Cannot be used for specifying the setting.
- telnet:Can be used for specifying the setting.

❖ **[IEEE 1394] → [IPv4 Address] → [Auto-Obtain (DHCP)]**

- Web Image Monitor:Can be used for specifying the setting.
- SmartDeviceMonitor for Admin:Cannot be used for specifying the setting.
- telnet:Can be used for specifying the setting.

❖ **[IEEE 1394] → [IPv4 Address] → [Specify] → [Machine IPv4 Address]**

- Web Image Monitor:Can be used for specifying the setting.
- SmartDeviceMonitor for Admin:Cannot be used for specifying the setting.
- telnet:Can be used for specifying the setting.

❖ **[IEEE 1394] → [IPv4 Address] → [Specify] → [Sub-net Mask]**

- Web Image Monitor:Can be used for specifying the setting.
- SmartDeviceMonitor for Admin:Cannot be used for specifying the setting.
- telnet:Can be used for specifying the setting.

❖ [IEEE 1394] → [DDNS Configuration]

- Web Image Monitor:Can be used for specifying the setting.
- SmartDeviceMonitor for Admin:Cannot be used for specifying the setting.
- telnet:Can be used for specifying the setting.

❖ [IEEE 1394] → [IPv4 over 1394]

- Web Image Monitor:Can be used for specifying the setting.
- SmartDeviceMonitor for Admin:Cannot be used for specifying the setting.
- telnet:Can be used for specifying the setting.

❖ [IEEE 1394] → [WINS Configuration] → [On] → [Primary WINS Server]

- Web Image Monitor:Can be used for specifying the setting.
- SmartDeviceMonitor for Admin:Cannot be used for specifying the setting.
- telnet:Can be used for specifying the setting.

❖ [IEEE 1394] → [WINS Configuration] → [On] → [Secondary WINS Server]

- Web Image Monitor:Can be used for specifying the setting.
- SmartDeviceMonitor for Admin:Cannot be used for specifying the setting.

❖ [IEEE 1394] → [WINS Configuration] → [On] → [Scope ID]

- Web Image Monitor:Can be used for specifying the setting.
- SmartDeviceMonitor for Admin:Cannot be used for specifying the setting.
- telnet:Can be used for specifying the setting.

❖ [IEEE 1394] → [Host Name]

- Web Image Monitor:Can be used for specifying the setting.
- SmartDeviceMonitor for Admin:Cannot be used for specifying the setting.
- telnet:Can be used for specifying the setting.

❖ [IEEE 1394] → [Domain Name]

- Web Image Monitor:Can be used for specifying the setting.
- SmartDeviceMonitor for Admin:Cannot be used for specifying the setting.
- telnet:Can be used for specifying the setting.

❖ [IEEE 802.11b] → [Communication Mode]

- Web Image Monitor:Can be used for specifying the setting.
- SmartDeviceMonitor for Admin:Cannot be used for specifying the setting.
- telnet:Can be used for specifying the setting.

❖ **[IEEE 802.11b] → [SSID Setting]**

- Web Image Monitor:Can be used for specifying the setting.
- SmartDeviceMonitor for Admin:Cannot be used for specifying the setting.
- telnet:Can be used for specifying the setting.

❖ **[IEEE 802.11b] → [Channel]**

- Web Image Monitor:Can be used for specifying the setting.
- SmartDeviceMonitor for Admin:Cannot be used for specifying the setting.
- telnet:Can be used for specifying the setting.

❖ **[IEEE 802.11b] → [Security Method]**

- Web Image Monitor:Can be used for specifying the setting.
- SmartDeviceMonitor for Admin:Cannot be used for specifying the setting.
- telnet:Can be used for specifying the setting.

❖ **[IEEE 802.11b] → [Transmission Speed]**

- Web Image Monitor:Cannot be used for specifying the setting.
- SmartDeviceMonitor for Admin:Cannot be used for specifying the setting.
- telnet:Can be used for specifying the setting.

❖ **[File Transfer] → [SMTP Server]**

- Web Image Monitor:Can be used for specifying the setting.
- SmartDeviceMonitor for Admin:Cannot be used for specifying the setting.
- telnet:Cannot be used for specifying the setting.

❖ **[File Transfer] → [SMTP Authentication]**

- Web Image Monitor:Can be used for specifying the setting.
- SmartDeviceMonitor for Admin:Cannot be used for specifying the setting.
- telnet:Cannot be used for specifying the setting.

❖ **[File Transfer] → [POP before SMTP]**

- Web Image Monitor:Can be used for specifying the setting.
- SmartDeviceMonitor for Admin:Cannot be used for specifying the setting.
- telnet:Cannot be used for specifying the setting.

❖ **[File Transfer] → [Reception Protocol]**

- Web Image Monitor:Can be used for specifying the setting.
- SmartDeviceMonitor for Admin:Cannot be used for specifying the setting.
- telnet:Cannot be used for specifying the setting.

❖ [File Transfer] → [POP3 / IMAP4 Settings]

- Web Image Monitor:Can be used for specifying the setting.
- SmartDeviceMonitor for Admin:Cannot be used for specifying the setting.
- telnet:Cannot be used for specifying the setting.

❖ [File Transfer] → [Administrator's E-mail Address]

- Web Image Monitor:Can be used for specifying the setting.
- SmartDeviceMonitor for Admin:Cannot be used for specifying the setting.
- telnet:Cannot be used for specifying the setting.

❖ [File Transfer] → [E-mail Communication Port]

- Web Image Monitor:Can be used for specifying the setting.
- SmartDeviceMonitor for Admin:Cannot be used for specifying the setting.
- telnet:Cannot be used for specifying the setting.

❖ [File Transfer] → [E-mail Reception Interval]

- Web Image Monitor:Can be used for specifying the setting.
- SmartDeviceMonitor for Admin:Cannot be used for specifying the setting.
- telnet:Cannot be used for specifying the setting.

❖ [File Transfer] → [Max. Reception E-mail Size]

- Web Image Monitor:Can be used for specifying the setting.
- SmartDeviceMonitor for Admin:Cannot be used for specifying the setting.
- telnet:Cannot be used for specifying the setting.

❖ [File Transfer] → [E-mail Storage in Server]

- Web Image Monitor:Can be used for specifying the setting.
- SmartDeviceMonitor for Admin:Cannot be used for specifying the setting.
- telnet:Cannot be used for specifying the setting.

❖ [File Transfer] → [Default User Name / Password (Send)]

- Web Image Monitor:Can be used for specifying the setting.
- SmartDeviceMonitor for Admin:Cannot be used for specifying the setting.
- telnet:Cannot be used for specifying the setting.

❖ [File Transfer] → [Fax E-mail Account]

- Web Image Monitor:Cannot be used for specifying the setting.
- SmartDeviceMonitor for Admin:Cannot be used for specifying the setting.
- telnet:Cannot be used for specifying the setting.

❖ **[File Transfer] → [Scanner Resend Interval Time]**

- Web Image Monitor:Cannot be used for specifying the setting.
- SmartDeviceMonitor for Admin:Cannot be used for specifying the setting.
- telnet:Cannot be used for specifying the setting.

❖ **[File Transfer] → [Number of Scanner Resends]**

- Web Image Monitor:Cannot be used for specifying the setting.
- SmartDeviceMonitor for Admin:Cannot be used for specifying the setting.
- telnet:Cannot be used for specifying the setting.

Connecting the Machine to a Telephone Line and Telephone

This section describes how to connect the machine to the telephone lines and select the line type.

1

Connecting the Telephone Line

To connect the machine to a telephone line, use a snap-in modular type connector.

Important

- Make sure the connector is the correct type before you start.

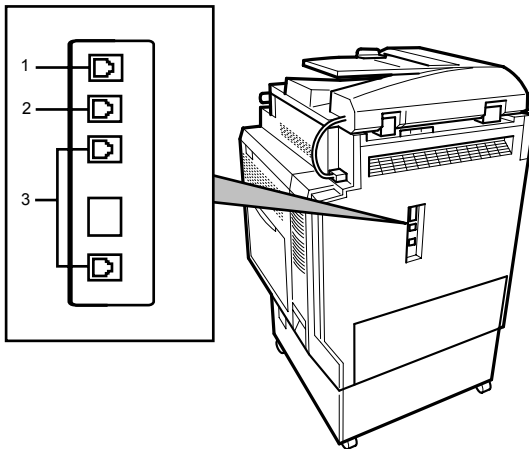

AMC025S

1. External telephone connector
2. G3 interface unit connector
3. Extra G3 interface unit connector

Selecting the Line Type

1

Select the line type to which the machine is connected. There are two types: tone and pulse dial.

Select the line type using "Administrator Tools".

 **Note**

This function is not available in some regions.

 **Reference**

p.135 "Select Dial / Push Phone"

2. System Settings

This chapter describes user tools in the System Settings menu.

For details on how to access **[System Settings]**, see "Accessing User tools (System Settings)".

Reference

p.3 "Accessing User Tools (System Settings)"

General Features

This section describes the user tools in the General Features menu under System Settings.

❖ Program / Change / Delete User Text

You can register text phrases you often use when specifying settings, such as ".com" and "Regards".

You can register up to 40 entries.

- Program / Change

- ① Press **[System Settings]**.
- ② Check that **[General Features]** is selected.
- ③ Press **[Program / Change / Delete User Text]**.
- ④ Press **[Program / Change]**
- ⑤ Select the user text you want to change.
To program new user text, press **[Not Programmed]**.
- ⑥ Press **[OK]**.
- ⑦ Press **[Exit]**.

- Delete

- ① Press **[System Settings]**.
- ② Check that **[General Features]** is selected.
- ③ Press **[Program / Change / Delete User Text]**.
- ④ Press **[Delete]**.
- ⑤ Select the user text you want to delete.
- ⑥ Press **[Clear]**.
- ⑦ Press **[Exit]**.

❖ Panel Tone

The beeper (key tone) sounds when a key is pressed.

- On
- Off

❖ Warm Up Notice (copier/Document Server)

You can have the beeper sound when the machine becomes ready to copy after leaving Energy Saver mode, or when the power is turned on.

- On
- Off

❖ Copy Count Display (copier/Document Server)

The copy counter can be set to show the number of copies made (count up) or the number of copies yet to be made (count down).

- Up
- Down

❖ Function Priority

Specify the mode to be displayed immediately after the operation switch is turned on, or when System Reset mode is turned on.

- Copier
- Document Server
- Fax
- Printer
- Scanner

❖ Print Priority

Print Priority is given to the mode selected.

- Display Mode
- Copier/Document Server
- Facsimile
- Printer
- Interleave
- Job Order

When **[Interleave]** is selected, the current print job will be interrupted after a maximum of five sheets.

❖ Function Reset Timer

You can set the length of time the machine waits before changing modes when using the multi-access function.

This is useful if you are making many copies and have to change settings for each copy. If you set a longer reset period, you can prevent interruption from other functions.

- Set Time
- Immediate

When you select **[Set Time]**, enter the time (3–30 seconds, in 1 second increments) using the number keys.

The default setting is 3 second(s).

❖ **Output: Copier (copier)**

Specify a tray to which documents are delivered.

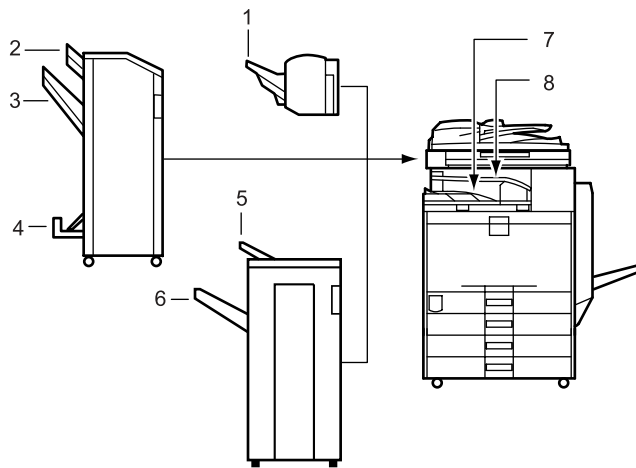

AMC002S

1. Finisher Shift Tray**2. Finisher Upper Tray****3. Finisher Shift Tray****4. Finisher Booklet Tray**

- Internal Tray 1
- Internal Tray 2
- Finisher Upper Tray
- Finisher Shift Tray

5. Finisher Upper Tray**6. Finisher Shift Tray****7. Internal Tray 1****8. Internal Tray 2**❖ **Output: Document Server (Document Server)**

Specify a tray to which documents are delivered.

- Internal Tray 1
- Internal Tray 2
- Finisher Upper Tray
- Finisher Shift Tray

❖ **Output: Facsimile (facsimile)**

Specify a tray to which documents are delivered.

- Internal Tray 1
- Internal Tray 2
- Finisher Upper Tray
- Finisher Shift Tray

❖ Output: Printer (printer)

Specify a tray to which documents are delivered.

The output trays set on the printer driver have priority over the output tray specified below.

- **Internal Tray 1**
- Internal Tray 2
- Finisher Upper Tray
- Finisher Shift Tray

❖ System Status/Job List Display Time

Specify how long to display the System Status and Job List display for.

- **On: 15 second(s)**
- Off

By selecting **[On]**, you can specify a display time between 10 and 999 seconds.

❖ Key Repeat

You can enable or disable repetition of an operation if a key on the screen or control panel is pressed continuously.

- Off
- **Normal**
- Repeat Time: Medium
- Repeat Time: Long

 Note

- If the Panel Tone setting is **[Off]**, the beeper does not sound, whatever the Warm Up Notice setting.
- The Function Reset Timer setting is ignored if Interleave is set for Print Priority.

 Reference

"Function Compatibility", Copy/Document Server Reference

Output tray settings

 Important

- You cannot interrupt the current stapling job even if a stapling job is specified by a different function.
- When the 500-sheet finisher, 1000-sheet finisher, or booklet finisher is installed and Staple or Shift Sort is specified for a job, the job will be delivered to the finisher shift tray regardless of the output tray specified.

Tray Paper Settings

This section describes the user tools in the Tray Paper Settings menu under System Settings.

Important

- If the specified paper size differs from the actual size of the paper loaded in the paper tray, a misfeed might occur because the correct paper size was not detected.

❖ Paper Tray Priority: Copier (copier/Document Server)

Specify the tray to supply paper for output.

- Tray 1
- Tray 2
- Tray 3 (optional)
- Tray 4 (optional)

When optional paper tray unit is installed, [Tray 3] and [Tray 4] is displayed.

When optional LCT is installed, [Tray 3] is displayed.

❖ Paper Tray Priority: Facsimile (facsimile)

Specify the tray to supply paper for output.

- Tray 1
- Tray 2
- Tray 3 (optional)
- Tray 4 (optional)

When optional paper tray unit is installed, [Tray 3] and [Tray 4] is displayed.

When optional LCT is installed, [Tray 3] is displayed.

❖ Paper Tray Priority: Printer (printer)

Specify the tray to supply paper for output.

- Tray 1
- Tray 2
- Tray 3 (optional)
- Tray 4 (optional)

When optional paper tray unit is installed, [Tray 3] and [Tray 4] is displayed.

When optional LCT is installed, [Tray 3] is displayed.

❖ Tray Paper Size: Tray 2-4

Select the size of the paper loaded in the paper tray.

❖ The paper sizes you can set for tray 2 are as follows:

"Auto Detect", "A3", "B4JIS", "A4", "A4", "B5JIS", "B5JIS", "A5", "11×17", "8¹/₂×14", "8¹/₂×11", "8¹/₂×11", "8¹/₄×14", "7¹/₄×10¹/₂", "7¹/₄×10¹/₂", "8×13", "8¹/₂×13", "8¹/₄×13", "8K", "16K", "16K"

❖ The paper sizes you can set for tray 3 are as follows:

- When optional paper tray unit is installed:
"Auto Detect", "A3", "B4JIS", "A4", "A4", "B5JIS", "B5JIS", "A5", "11×17", "8¹/₂×14", "8¹/₂×11", "8¹/₂×11", "8¹/₄×14", "7¹/₄×10¹/₂", "7¹/₄×10¹/₂", "8×13", "8¹/₂×13", "8¹/₄×13", "8K", "16K", "16K"
- When optional LCT is installed:
"A4", "8¹/₂×11"

❖ The paper sizes you can set for tray 4 are as follows:

"Auto Detect", "A3", "B4JIS", "A4", "A4", "B5JIS", "B5JIS", "A5", "11×17", "8¹/₂×14", "8¹/₂×11", "8¹/₂×11", "8¹/₄×14", "7¹/₄×10¹/₂", "7¹/₄×10¹/₂", "8×13", "8¹/₂×13", "8¹/₄×13", "8K", "16K", "16K"

❖ Printer Bypass Paper Size

Specify the size of the paper in the bypass tray when printing data from the computer.

❖ The paper sizes you can set for bypass tray are as follows:

"A3", "B4JIS", "A4", "A4", "B5JIS", "B5JIS", "A5", "A5", "B6JIS", "A6", "12×18", "11×17", "8¹/₂×14", "8¹/₂×11", "8¹/₂×11", "5¹/₂×8¹/₂", "5¹/₂×8¹/₂", "7¹/₄×10¹/₂", "7¹/₄×10¹/₂", "8×13", "8¹/₂×13", "8¹/₄×13", "4¹/₈×9¹/₂", "3⁷/₈×7¹/₂", "C6", "C5", "DLEnv", "8K", "16K", "16K"

Specify a custom size of between 90.0-305.0mm (3.55"-12.00") vertically, and between 148.0-600.0mm (5.83"-23.62") horizontally.

❖ Paper Type: Bypass Tray

Sets the display so you can see what type of paper is loaded in the bypass tray.

- Paper Type
 - **No Display**
 - Recycled Paper
 - Colour Paper
 - Letterhead
 - Label Paper
 - OHP (Transparency)
 - Special Paper 1-3
 - Cardstock
 - Preprinted Paper
 - Bond Paper
- Paper Thickness
 - Thin Paper
 - Normal (60-81g/m², 16-22lb.)
 - Middle Thick (82-105g/m², 22-28lb.)
 - Thick 1 (106-169g/m², 28.5-44.9lb.)
 - Thick 2 (170-219g/m², 45-58lb.)
 - Thick 3 (220-253g/m², 58.5-67lb.)

❖ Paper Type: Tray 1-4

Sets the display so you can see what type of paper is loaded in each paper tray. The print function use this information to automatically select the paper tray.

- Paper Type
 - **No Display**
 - Recycled Paper
 - Colour Paper
 - Letterhead
 - Label Paper
 - Special paper 1-3
 - Cardstock
 - Preprinted Paper
 - Bond Paper

- Paper Thickness
 - Thin Paper
 - Normal (60-81g/m², 16-22lb.)
 - Middle Thick (82-105g/m², 22-28lb.)
 - Thick 1 (106-169g/m², 28.5-44.9lb.)
 - Thick 2 (170-219g/m², 45-58lb.)
- Copying Method in Duplex
 - **2 Sided Copy**
 - 1 Sided Copy
- Apply Auto Paper Select
 - **Yes**
 - No

❖ **Cover Sheet Tray**

Allows you to specify and display the paper tray that is setting cover sheets. After selecting the paper tray, you can also specify the display timing and copy method for two-sided copying.



- Tray to Program
 - **Off**
 - Bypass Tray
 - Tray 1
 - Tray 2
 - Tray 3 (optional)
 - Tray 4 (optional)
- Copying Method in Duplex
 - 2 Sided Copy
 - 1 Sided Copy
- Display Time
 - At Mode Selected
 - Full Time

❖ Slip Sheet Tray

Allows you to specify and display the paper tray that is inserting slip sheets. After selecting the paper tray, you can also specify the display timing and copy method for two-sided copying.

- Tray to Program
 - Off
 - Bypass Tray
 - Tray 1
 - Tray 2
 - Tray 3 (optional)
 - Tray 4 (optional)
- Copying Method in Duplex
 - 2 Sided Copy
 - 1 Sided Copy
- Display Time
 - At Mode Selected
 - Full Time

Note

- The paper guide for the optional LCT is fixed for A4 , 8 1/2"×11"  size paper. Contact your service representative if you need to change the paper size.
- When paper of the same type and size is loaded in two different paper trays and you want to specify tray for 2 Sided Copy. If one of the trays is specified as the default in Paper Tray Priority, assign 2 Sided Copy to that tray.
- A  mark appears next to the paper tray if **[Off]** is selected in **[Auto Paper Select]**.
- [Auto Paper Select]** can only be selected for the copier function if **[No Display]** and **[Recycled Paper]** are selected. If **[No]** is selected, Auto Paper Select is not valid for the tray.
- Functions using the cover sheet tray setting are the front cover function and front/back cover function.
- If you set "Display Time" to "At Mode Selected" in "Cover Sheet Tray" and "Slip Sheet Tray", the trays selected for the cover sheets and slip sheets are indicated only if you have enabled the use of cover sheets and slip sheets.

Reference

"Covers", Copy/ Document Server Reference

"Slip Sheets", Copy/ Document Server Reference

Timer Settings

This section describes the user tools in the Timer Settings menu under System Settings.

❖ Auto Off Timer

After a specified period has passed, following job completion, the machine automatically turns off, in order to conserve energy. This function is called "Auto Off". The machine status after the Auto Off operation is referred to as "Off mode", or "Sleep mode". For the Auto Off Timer, specify the time to elapse before Auto Off.

The default setting is **60 minute(s)**.

The time can be set from 1 to 240 minutes, using the number keys.

Auto Off may not work when error messages appear.

❖ Energy Saver Timer

Set the amount of time the machine waits before switching to lower-power mode after copying has finished or the last operation is performed.

The time can be set from 1 to 240 minutes, using the number keys.

The default setting is **15 minute(s)**.

❖ Panel Off Timer

Set the amount of time the machine waits before switching the panel off after copying has finished or the last operation is performed.

The warm up time for making a copy from standby mode is 3 seconds for Panel off Level 1 and 15 seconds for Panel off Level 2.

Enter a time interval between 10 seconds and 240 minutes, using the number keys.

The default setting is **1 minute(s)**.

❖ System Auto Reset Timer

The System Reset setting automatically switches the screen to that of the function set in Function Priority when no operations are in progress, or when an interrupted job is cleared. This setting determines the system reset interval.

- On
- Off

The time can be set from 10 to 999 seconds, using the number keys

The default setting is **60 second(s)**.

❖ Copier/Document Server Auto Reset Timer (copier/Document Server)

Specifies the time to elapse before copier and Document Server modes reset.

- On
- Off

If **[Off]** is selected, the machine does not automatically switch to the user code entry screen.

The time can be set from 10 to 999 seconds, using the number keys.

The default setting is **60 second(s)**.

❖ Facsimile Auto Reset Timer (facsimile)

Specifies the time to elapse before the facsimile mode resets.

The time can be set from 30 to 999 seconds, using the number keys.

The default setting is **30 second(s)**.

❖ Printer Auto Reset Timer (printer)

Specifies the time to elapse before the printer function resets.

- **On**

- **Off**

The time can be set from 10 to 999 seconds, using the number keys.

The default setting is **60 second(s)**.

❖ Scanner Auto Reset Timer (scanner)

Specifies the time to elapse before the scanner function resets.

- **On**

- **Off**

If **[Off]** is selected, the machine will not automatically switch to the user code entry screen.

The time can be set from 10 to 999 seconds, using the number keys.

The default setting is **60 second(s)**.

❖ Set Date

Set the date for the copier's internal clock using the number keys.

To change between year, month, and day, press **[←]** and **[→]**.

❖ Set Time

Set the time for the copier's internal clock using the number keys.

Enter the time using the 24-hour format (in 1 second increments).

To change between hours, minutes and seconds, press **[←]** and **[→]**.

❖ Auto Logout Timer

Specify whether or not to automatically log out a user when the user does not operate the machine for a specified period of time after logging in.

- **On**

- **Off**

When **[On]** is selected, the time can be set from 60 to 999 seconds, in one second increments, using the number keys.

The default setting is **180 second(s)**.

Interface Settings

This section describes the user tools in the Interface Settings menu under System Settings.

Network

This section describes the user tools in the Network menu under Interface Settings.

❖ Machine IPv4 Address

Before using this machine in the network environment, you must specify the IPv4 address and subnet mask.

When you select **[Specify]**, enter the **[Machine IPv4 Address]** and **[Sub-net Mask]** as "xxx.xxx.xxx.xxx" ("x" indicates a number).

If the IEEE 1394 interface board is installed, and you are using the IEEE 1394 interface, you must set the address of the domain, different from the **[IPv4 Address]** of **[IEEE 1394]**. If you to set the address for the same domain, set a different value for the **[Sub-net Mask]**.

When you select **[Specify]**, make sure that **[Machine IPv4 Address]** is different from that of another machines on the network.

The physical address (MAC address) also appears.

If you use Ethernet and IEEE 1394 (IPv4 over 1394) interfaces at the same time, settings must be made carefully.

- **Auto-Obtain (DHCP)**
- Specify
 - Machine IPv4 Address: 011.022.033.044
 - Sub-net Mask: 000.000.000.000

❖ IPv4 Gateway Address

A gateway is a connection or interchange point between two networks.

Specify the gateway address for the router or host computer used as a gateway.

- IPv4 Gateway Address: **000.000.000.000**

❖ Machine IPv6 Address

Specify the machine's IPv6 network address.

- Link-local Address
The machine's specified link-local address appears.
- Manual Configuration Address
The machine's manually configuration address appears.
- Stateless Address: 1-5
The specified stateless address appears.

❖ IPv6 Gateway Address

Displays the machine's IPv6 gateway address.

❖ IPv6 Stateless Address Autoconfiguration

Specify IPv6 Stateless Address Autoconfiguration.

- **Active**
- Inactive

❖ DNS Configuration

Make settings for the DNS server.

When you select **[Specify]**, enter the DNS Server IPv4 address as "xxx.xxx.xxx.xxx" ("x" indicates a number).

- **Auto-Obtain (DHCP)**
- Specify
 - DNS Server 1: 000.000.000.000
 - DNS Server 2: 000.000.000.000
 - DNS Server 3: 000.000.000.000

❖ DDNS Configuration

Specify the DDNS settings.

- **Active**
- Inactive

❖ Domain Name

Specify the domain name.

- **Auto-Obtain (DHCP)**
- Specify

❖ WINS Configuration

Specify the WINS server settings.

If **[On]** is selected, enter the WINS Server IPv4 address as "xxx.xxx.xxx.xxx" ("x" indicates a number).

If DHCP is in use, specify the **[Scope ID]**.

Enter a **[Scope ID]** using up to 31 characters.

- On
 - Primary WINS Server:000.000.000.000
 - Secondary WINS Server:000.000.000.000
 - Scope ID
- **Off**

❖ Effective Protocol

Select the protocol to use in the network.

- IPv4: **Active** / Inactive
- IPv6: Active / **Inactive**
- NetWare: **Active** / Inactive
- SMB: **Active** / Inactive
- AppleTalk: **Active** / Inactive

❖ NCP Delivery Protocol

Select the protocol for NCP delivery.

- IPX Priority
- **TCP / IP Priority**
- IPX Only
- TCP / IP Only

If you select “IPX Only” or “TCP / IP Only”, you cannot switch the protocol even if you cannot connect with it. If “NetWare” in **[Effective Protocol]** is set to “Inactive”, you can only use TCP/IP.

❖ NW Frame Type

Select the frame type when you use NetWare.

- **Auto Select**
- Ethernet II
- Ethernet 802.2
- Ethernet 802.3
- Ethernet SNAP

❖ SMB Computer Name

Specify the SMB computer name.

Enter the computer name using up to 15 characters.

"*+,:;<>=?[\]|. and spaces cannot be entered.

Do not set a computer name starting with RNP and rnp.

Use uppercase letters for alphabets.

❖ SMB Work Group

Specify the SMB work group.

Enter the computer name using up to 15 characters.

"*+,:;<>=?[\]|. and spaces cannot be entered.

Use uppercase letters for alphabet.

❖ Ethernet Speed

Set the access speed for networks.

Select a speed that matches your network environment. **[Auto Select]** should usually be selected.

- **Auto Select**
- 10Mbps Full Duplex
- 10Mbps Half Duplex
- 100Mbps Full Duplex
- 10Mbps Half Duplex

❖ LAN Type

When you have installed the IEEE 802.11b interface unit, select the method of connection.

- Ethernet
- IEEE 802.11b

[LAN Type] is displayed when wireless LAN board is installed. If Ethernet and IEEE 802.11b (wireless LAN) are both connected, the selected interface has priority.

❖ Ping Command

Check the network connection with ping command using given IPv4 address. If you fail to connect to the network, check the following, and then retry the ping command.

- Make sure that “IPv4” in **[Effective Protocol]** is set to “Effective”.
- Check that the machine with assigned IPv4 address is connected to the network.
- There is a possibility that same IPv4 address is used for the specified equipment.

❖ Permit SNMPv3 Communication

Set the encrypted communication of SNMPv3.

- Encryption Only
- Encryption / Clear Text

If you select to **[Encryption Only]**, you need to set an encryption password for the machine.

❖ Permit SSL/TLS Communication

Set the encrypted communication of SSL/TLS.

- Ciphertext Only
- Ciphertext Priority
- Ciphertext / Clear Text

If you set to **[Ciphertext Only]**, you need to install the SSL certificate for the machine.

❖ Host Name

Specify the host name.

Enter the host name using up to 63 characters.

❖ Machine Name

Specify the machine name.

Enter the machine name using up to 31 characters.

Parallel Interface

This section describes the user tools in the Parallel Interface menu under Interface Settings.

[Parallel Interface] is displayed when this machine is installed with the IEEE 1284 interface board.

2

❖ Parallel Timing

Sets the timing for the control signal of the parallel interface.

- **ACK Outside**
- ACK Inside
- STB Down

❖ Parallel Communication Speed

Sets the communication speed for the parallel interface.

- **High Speed**
- Standard

❖ Selection Signal Status

Sets the level for the select signal of the parallel interface.

- **High**
- Low

❖ Input Prime

Sets whether to validate or invalidate the input prime signal upon reception.

- Active
- **Inactive**

❖ Bidirectional Communication

Sets the printer's response mode to a status acquisition request when using a parallel interface.

- **On**
- Off

When set to **[Off]**, bidirectional communication function will be disabled, and the printer driver will not be installed under Windows Auto Detect function.

❖ Signal Control

Specify how error during printing or sending facsimile from the computer is to be dealt with.

- **Job Acceptance Priority**
- Printer Priority

IEEE 1394

This section describes the user tools in the IEEE 1394 menu under Interface Settings.

[IEEE 1394] is displayed when this machine is installed with the IEEE 1394 interface board.

❖ IPv4 Address

Before using this machine in the network environment, you must specify the IPv4 address and subnet mask.

When you select **[Specify]**, enter the **[Machine IPv4 Address]** and **[Sub-net Mask]** as "xxx.xxx.xxx.xxx" ("x" indicates a number).

If the IEEE 1394 interface board is installed, and you are using the IEEE 1394 interface, you must set the address of the domain, different from the **[IPv4 Address]** of **[IEEE 1394]**. If you to set the address for the same domain, set a different value for the **[Sub-net Mask]**.

When you select **[Specify]**, make sure that **[Machine IPv4 Address]** is different from that of another machines on the network.

The physical address (MAC address) also appears.

If you use Ethernet and IEEE 1394 (IPv4 over 1394) interfaces at the same time, settings must be made carefully.

- **Auto-Obtain (DHCP)**
- Specify
 - Machine IPv4 Address: 011.022.033.044
 - Sub-net Mask: 000.000.000.000

❖ DDNS Configuration

Specify the DDNS settings.

- **Active**
- **Inactive**

❖ Host Name

Specify the host name.

Enter the host name using up to 63 characters.

❖ Domain Name

Make settings for the domain name.

- **Auto-Obtain (DHCP)**
- Specify
 - Enter the domain name using up to 63 characters.

❖ WINS Configuration

Specify the WINS server settings.

If **[On]** is selected, specify the WINS Server IPv4 address as "xxx.xxx.xxx.xxx" ("xxx" indicates a number).

If DHCP is in use, specify the **[Scope ID]**.

Enter **[Scope ID]** using up to 31 characters.

- **On**
 - Primary WINS Server:000.000.000.000
 - Secondary WINS Server:000.000.000.000
 - Scope ID
- **Off**

❖ IPv4 over 1394

When you use the IPv4 over 1394 function of the IEEE 1394 interface to connect the machine to the network, or you print from computer with the IPv4 over 1394 driver, you must specify **[Active]** for **[IPv4 over 1394]**.

- **Active**
- Inactive

Printing with IPv4 over 1394 is possible under Windows Me/XP and Windows Server 2003.

❖ SCSI print (SBP-2)

When you print using the SCSI print client function supported by Windows 2000/XP, or Windows Server 2003, you must set **[SCSI print (SBP-2)]**.

- **Active**
- Inactive

❖ Bidirectional SCSI print

Specifies the printer's response mode etc. for status requests when using the IEEE 1394 interface.

- **On**
- **Off**

If this is set to **[Off]** bidirectional communication will not work.

IEEE 802.11b

This section describes the user tools in the IEEE 802.11b menu under Interface Settings.

[IEEE 802.11b] is displayed when this machine is installed with the wireless LAN interface board.

Be sure to make all settings simultaneously.

❖ Communication Mode

Specifies the communication mode of the wireless LAN.

- **802.11 Ad-hoc Mode**
- Ad-hoc Mode
- Infrastructure Mode

❖ SSID Setting

Specifies SSID to distinguish the access point in infrastructure mode or 802.11 ad hoc mode.

The characters that can be used are ASCII 0x20-0x7e (32 bytes).

If blank is specified in 802.11b ad hoc mode or ad hoc mode, "ASSID" appears.

❖ Channel

Specifies a channel when you select 802.11b ad hoc mode or ad hoc mode.

The default setting is **11**.

The following channels are available:

- Metric version: 1-14
- Inch version: 1-11

❖ Security Method

Specifies the encryption of the IEEE 802.11b (wireless LAN).

If set to **[WEP]**, always enter WEP key. If set to **[WPA]**, the encryption and authentication methods.

Specify "WPA", when **[Communication Mode]** is set to **[Infrastructure Mode]**.

- **Off**
- WEP
- WPA
 - WPA Encryption Method
Select either "TKIP" or "CCMP(AES)".
 - WPA Authent. Method
Select either "WPA-PSK" or "WPA802.1X)". If you have selected "WPA-PSK", enter the pre-shared key (PSK) of 8- 63 characters in ASCII code.

❖ **Wireless LAN Signal**

When using in infrastructure mode, you can check the machine's radio wave status using the control panel.

Radio wave status is displayed when you press **[Wireless LAN Signal]**.

❖ **Transmission Speed**

Specifies the communication speed of the IEEE 802.11b (wireless LAN).

- **Auto Select**
- 11Mbps Fixed
- 5.5Mbps Fixed
- 2Mbps Fixed
- 1Mbps Fixed

❖ **Restore Factory Defaults**

You can return the IEEE 802.11b (wireless LAN) settings to their defaults.

- No
- Yes

Print List

You can check items related to the network environment.

The configuration page shows the current network settings and network information.

1 Press **[System Settings]**.

2 Press **[Interface Settings]**.

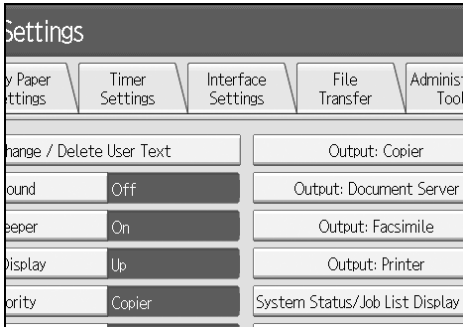

3 Press **[Print List]**.

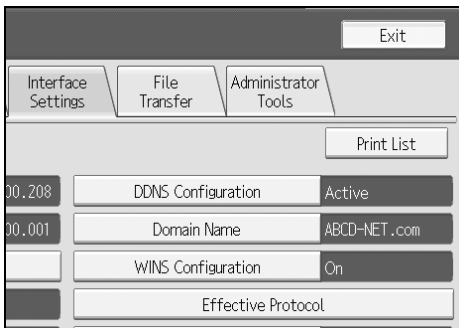

4 Press the **[Start]** key.

The configuration page is printed.

5 Press **[Exit]**.

6 Press the **[User Tools/Counter]** key.

Note

- You can also exit by pressing **[Exit]** on the User Tools main menu.

File Transfer

This section describes the user tools in the File Transfer menu under System Settings.

❖ Delivery Option

Enables or disables sending stored or scanned documents to the ScanRouter delivery server.

- On
 - Main Delivery Server IPv4 Address
 - Sub Delivery Server IPv4 Address
- **Off**

Specify this option when selecting whether or not to use the ScanRouter delivery software. If you do, you will have to preregister I/O devices in the ScanRouter delivery software.

❖ Capture Server IP Address

Specify the capture server IPv4 address.

This setting appears when the media link board is installed, and that the capture function is being used by the ScanRouter delivery software.

❖ Fax RX File Transmission

Specify how to deliver fax files received via the different lines.

- Setting per Line
 - Line 1
 - Line 2
 - Line 3
 - E-mail
 - IP-Fax

The lines appear according to the operating environment.

- RX File Delivery
 - Specifies whether or not received fax documents are sent to the ScanRouter delivery software for each fax line.
 - Deliver to Server
 - **Do not Deliver**
- Print at Delivery
 - Specifies whether or not received fax documents sent to the ScanRouter delivery software should also be printed at the same time.
 - Print
 - **Do not Print**

- **File to Deliver**
Specify whether all received fax documents or only received fax documents that include delivery codes (ID or SUB/SEP codes) are sent to the ScanRouter delivery software.

- File with Delivery Code

- **Print File**

- **Delivery Failure File**

If a received fax document cannot be sent to the ScanRouter delivery software, it is stored in memory. To print a stored file, select **[Print File]**, to delete, select **[Delete File]**.

If the machine can send the data to the ScanRouter delivery software, it does so automatically. If you delete the data, you will not be able to distribute or print it.

- Print File
- Delete File

❖ **SMTP Server**

When using DNS, enter the host name.

When not using DNS, enter the SMTP server IPv4 address.

- Server Name
- Port No.: 25

Enter the server name using up to 127 characters. Spaces cannot be entered. Enter port number between 1 and 65535 using the number keys, and then press the **[#]** key.

❖ **SMTP Authentication**

Specify SMTP authentication (PLAIN, LOGIN, CRAMMD5, DIGEST-MD5).

When sending e-mail to an SMTP server, you can enhance the SMTP server security level using authentication that requires entering the user name and password.

If the SMTP server requires authentication, set **[SMTP Authentication]** to **[On]**, and then specify the user name, password and encryption.

Enter the user name and password to be set for the Administrator's e-mail address when using Internet Fax.

- SMTP AUTH
 - On
 - User Name
Enter the user name using up to 191 characters. Spaces cannot be entered. Depending on the SMTP server type, "realm" must be specified. Add "@" after the user name, as in "user name@realm".
 - E-mail Address
 - Password
Enter the password using up to 63 characters. Spaces cannot be entered.
 - Encryption: **Auto** / On / Off
 - [Encryption]-[Auto]**: Use If the authentication method is PLAIN, LOGIN, CRAM-MD5, or DIGEST-MD5.
 - [Encryption]-[On]**: Use If the authentication method is CRAMMD5 or DIGEST-MD5.
 - [Encryption]-[Off]**: Use If the authentication method is PLAIN, or LOGIN.
 - Off

❖ POP before SMTP

Specify POP authentication (POP before SMTP).

When sending e-mail to an SMTP server, you can enhance the SMTP server security level by connecting to the POP server for authentication.

To enable POP server authentication before sending e-mail via the SMTP server, set **[POP before SMTP]** to **[On]**. E-mail is sent to the SMTP server after the time specified for **[Wait Time after Authent.]** has elapsed.

If you select **[On]**, enter **[Server Name]** in **[POP3 / IMAP4 Settings]**. Also, check the port number for **[POP3]** in **[E-mail Communication Port]**.

- On
 - Wait Time after Authent.: **300 msec.**
Specify **[Wait Time after Authent.]** from zero to 10,000 milliseconds, in increments of one millisecond.
 - User Name
Enter the user name using up to 63 characters. Spaces cannot be entered.
 - E-mail Address
 - Password
Enter the password using up to 63 characters. Spaces cannot be entered.
- Off

❖ Reception Protocol

Specify Reception Protocol for receiving Internet Fax.

- POP3
- IMAP4
- SMTP

❖ POP3 / IMAP4 Settings

Specify the POP3/IMAP4 server name for receiving Internet faxes. The specified POP3/IMAP4 server name is used for **[POP before SMTP]**.

- Server Name
If DNS is in use, enter the host name.
If DNS is not in use, enter the POP3/IMAP4 or server IPv4 address.
Enter POP3/IMAP4 server name using up to 127 characters. Spaces cannot be entered.
- Encryption
 - **Auto**
Password encryption is automatically set according to the POP/IMAP server settings.
 - On
Encrypt password.
 - Off
Do not encrypt password.

❖ Administrator's E-mail Address

On e-mailed scanned documents, if the sender is not specified this appears as the sender's address.

When sending e-mail under the Internet fax function, administrator's e-mail address will appear as the sender's address under the following conditions:

- The sender has not been specified and the machine's e-mail address has not been registered.
- The specified sender is not registered in the machine's address book and the machine's e-mail address has not been registered.

When conducting SMTP authentication for the transmitted files under the Internet fax function, the Administrator's E-mail Address will appear in the "From:" box. If you have specified the user name and e-mail address in **[SMTP Authentication]**, make sure to specify this setting.

Enter within up to 128 characters.

On e-mailed scanned documents, if **[Auto Specify Sender Name]** is **[Off]**, specify the sender.

❖ E-mail Communication Port

Specify the port numbers for receiving Internet faxes. The specified POP3 port number is used for **[POP before SMTP]**.

- POP3: 110
- IMAP4: 143
- SMTP: 25

Enter a port number between 1 and 65535 using the number keys, and then press the **[#]** key.

❖ E-mail Reception Interval

Specify, in minutes, the time interval for receiving Internet faxes via POP3 or IMAP4 server.

- **On: 15 minute(s)**
- Off

If **[On]** is selected, the time interval can be specified from 2 to 1440 in increments of one minute.

❖ Max. Reception E-mail Size

Specify the maximum reception e-mail size for receiving Internet faxes.

- **2MB**

Enter a size from one to 50 MB in increments of one megabyte.

❖ E-mail Storage in Server

Specify whether or not to store received Internet fax e-mails on the POP3 or IMAP4 server.

- **Off**
- All
- Errors Only

❖ Default User Name / Password (Send)

Specify the user name and password required when sending scan file directly to a shared folder on a computer running Windows, to an FTP server, or to a NetWare server.

- SMB User Name
- SMB Password
- FTP User Name
- FTP Password
- NCP User Name
- NCP Password

Enter in up to 64 characters.

❖ Program / Change / Delete E-mail Message

You can program, change, or delete the e-mail message used when sending an Internet fax or scan file as an attachment.

• Program / Change

- ① Press **[System Settings]**.
- ② Press **[File Transfer]**.
- ③ Press **[▼Next]**.
- ④ Press **[Program / Change / Delete E-mail Message]**.
- ⑤ Press **[Program / Change]**.
- ⑥ Press **[Not Programmed]**.
- ⑦ Press **[Change]**.
- ⑧ Enter a name, and then press **[OK]**.
Enter the name using up to 20 characters.
- ⑨ Press **[Edit]**.
To start a new line, press **[OK]** to return to the e-mail message screen, and then press **[▼]** in "Select Line to Edit:".
- ⑩ Enter the text, and then press **[OK]**.
Enter up to five lines of text. Each line can consist of up to 80 characters.
- ⑪ Press **[OK]**.
- ⑫ Press **[Exit]**.

• Delete

- ① Press **[System Settings]**.
- ② Press **[File Transfer]**.
- ③ Press **[▼Next]**.
- ④ Press **[Program / Change / Delete E-mail Message]**.
- ⑤ Press **[Delete]**.
- ⑥ Select the e-mail message to delete.
The confirmation message about deleting appears.
- ⑦ Press **[Yes]**.

❖ Auto Specify Sender Name

Set whether or not to specify the name of the sender when sending e-mail.

- **On**
If you select **[On]**, the specified e-mail address will appear in the "From:" box. If you do not specify the sender's address, the administrator's e-mail address will appear in the "From:" box.
If you do not specify the sender when sending a file by e-mail under the fax function, or if the specified e-mail address is not registered in the machine's address book, the machine's e-mail address will appear in the "From:" box. If the machine does not have an e-mail address, the administrator's e-mail address will appear in the "From:" box.
- **Off**
If you select **[Off]**, the specified e-mail address will appear in the "From:" box, but you cannot send e-mail without specifying the sender's e-mail address. Under the fax function, you cannot send e-mail if the specified sender's e-mail address is not registered in the machine's address book.

❖ Fax E-mail Account

Specify e-mail address, user name and password for receiving Internet faxes.

- **Receive**
 - **E-mail Address**
Enter an e-mail address using up to 128 characters.
 - **User Name**
Enter a user name using up to 64 characters.
 - **Password**
Enter a password using up to 64 characters.
- **Do not Receive**

❖ Scanner Resend Interval Time

Specifies the interval the machine waits before resending a scan file, if they cannot be sent to the delivery server or mail server.

The default setting is **300 second(s)**.

The interval time can be set from 60 to 999 seconds in one second increments, using the number keys.

This setting is for the scanner function.

❖ Number of Scanner Resends

Sets a maximum number of times scan file is resent to the delivery server or mail server.

- **On: 3 time(s)**
- **Off**

If **[On]** is selected, the number of times can be set from 1 to 99. This setting is for the scanner function.

This setting is for the scanner function.

Administrator Tools

This section describes the user tools in the Administrator Tools menu under System Settings.

Administrator Tools are used by the administrator. To change these settings, contact the administrator.

We recommend specifying Administrator Authentication before making Administrator Tools settings.

❖ Address Book Management

You can add, change or delete information registered in the Address Book. For details, see "Address Book".

- Program / Change

You can register and change names as well as user codes.

- Names

You can register a name, key display, registration number, and title selection.

- Auth. Info

You can register a user code, and specify the functions available to each user code. You can also register user names and passwords to be used when sending e-mail, sending files to folders, or accessing an LDAP server.

- Protection

You can register a protection code.

- Fax Dest.

You can register a fax number, international TX mode, fax header, label insertion, IP-Fax destination, and protocol.

- E-mail

You can register an e-mail address.

- Folder

You can register the protocol, path, port number, and server name.

- Add to Group

You can put names registered in the Address Book into a group.

- Delete

You can delete a name from the Address Book.

You can register up to 2,000 names.

You can register up to 500 user codes.

You can also register and manage names in the Address Book using Web Image Monitor or SmartDeviceMonitor for Admin.

❖ Address Book: Program / Change / Delete Group

Names registered in the Address Book can be added into a group. You can then easily manage the names registered in each group.

- Program / Change
You can register and change groups.
 - Names
You can register a name, key display, registration number, and title selection.
 - Programmed User/Group
You can check the names or groups registered in each group.
 - Protection
You can register a protection code.
 - Add to Group
You can put groups registered in the Address Book into a group.
- Delete
You can delete a group from the Address Book.

You can register up to 100 groups.

You can also register and manage groups in the Address Book using Web Image Monitor or SmartDeviceMonitor for Admin.

Use SmartDeviceMonitor for Admin provided with the printer scanner unit.

❖ Address Book: Change Order

Changes the order of registered name.

You can rearrange the order of items on the same page, but you cannot move items to another page.

For example, you cannot move an item from “PLANNING” ([OPQ]) to “DAILY” ([CD]).

- ① Press **[System Settings]**.
- ② Press **[Administrator Tools]**.
- ③ Press **[Address Book: Change Order]**.

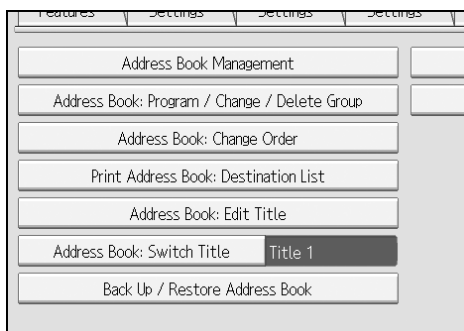

- ④ Press the name key to be move.

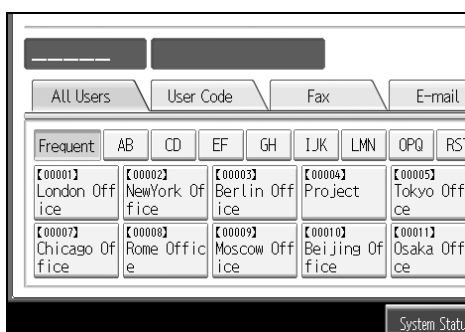

You can select a name using the number keys.

- ⑤ Press the name key in the place you want to move to.

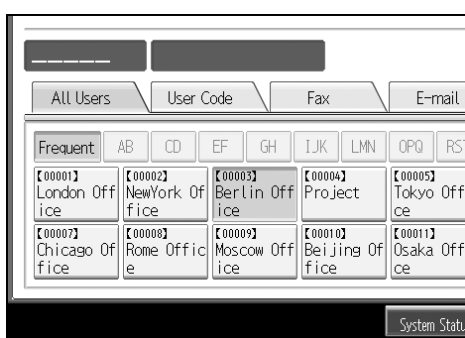

The user key is moved to the selected position, and the user key currently at the selected position is moved forward or backward.

If you move the selected user key forward, the user key currently at the selected position is moved backward.

If you move the selected user key backward, the user key currently at the selected position is moved forward.

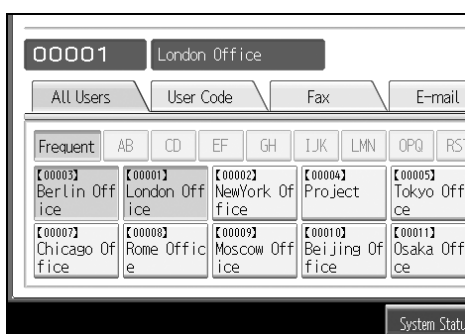

You can also select a name using the number keys.

❖ Print Address Book: Destination List

You can print the destination list registered in the Address Book.

- Print in Title 1 Order
Prints the Address Book in Title 1 order.
- Print in Title 2 Order
Prints the Address Book in Title 2 order.
- Print in Title 3 Order
Prints the Address Book in Title 3 order.
- Print Group Dial List
Prints the group Address Book.

- ① Press **[System Settings]**.
- ② Press **[Administrator Tools]**.
- ③ Press **[Print Address Book: Destination List]**.
- ④ Select the print format.
- ⑤ To print the list on two-sided pages, select **[Print on 2 Sides]**.
- ⑥ Press the **[Start]** key.
The list prints out.

❖ Address Book: Edit Title

You can edit the title to easily find a user.

- ① Press **[System Settings]**.
- ② Press **[Administrator Tools]**.
- ③ Press **[Address Book: Edit Title]**.

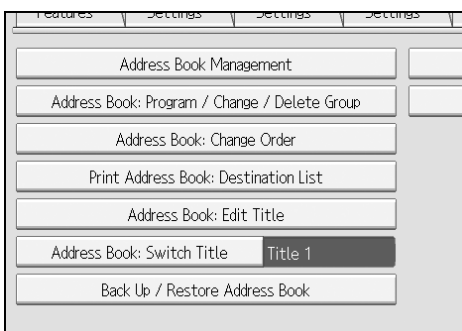

- ④ Press the title key you want to change.

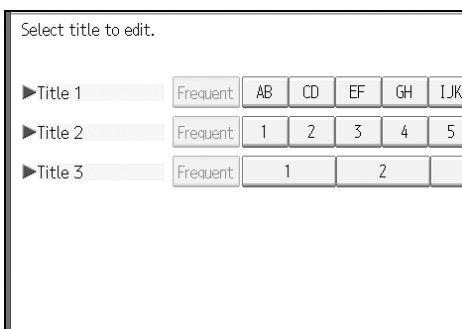

- ⑤ Enter the new name, and then press **[OK]**.
- ⑥ Press **[OK]**.

❖ **Address Book: Switch Title**

Specifies the title to select a name.

- **Title 1**
- Title 2
- Title 3

❖ **Back Up / Restore Address Book**

You can back up the machine's address book to external storage or restore the backup copy from the external storage.

- **Back Up**
You can back up the machine's address book to external storage.
- **Restore**
You can restore the backup copy of the address book from external storage.
- **Format**
You can format the external storage.
- **Obtain Media Info**
The free space and occupied space of the external storage are displayed.

❖ **Display/Print Counter**

Allows you to view and print the number of prints.

- **Display/Print Counter**
Displays the number of prints for each function (Total, Copier, Facsimile, Printer, A3/DLT, Duplex, and Staple).
- **Print Counter List**
Prints out a list of the number of prints made under each function.

❖ **Display/Clear/Print Counter per User**

Allows you to view and print the numbers of prints accessed with user codes, and to set those values to 0.

Press **[▲Previous]** and **[▼Next]** to show all the numbers of prints.

The number of prints may differ from the counter value shown in Display/Print Counter.

- **Print Counter for All Users**
Prints the counter values for all the users.
- **Clear Counter for All Users**
Sets the counter value for all the users.
- **Print Counter per User**
Prints the counter values for each user.
- **Clear Counter per User**
Sets the counter value for each user.

❖ User Authentication Management

- User Code Auth.
Using User Code Authentication, you can limit the available functions and supervise their use.

When using User Code Authentication, register the user code.

Using the Printer PC Control function, you can obtain a log of prints corresponding to the codes entered using the printer driver.

If User Code Authentication has been specified, Auto Colour Select cannot be used.

For details about Basic Authentication, Windows Authentication, LDAP Authentication, and Integration Server Authentication, consult your administrator.

- Copier
- Printer
- Other Functions
- Printer Job Authentication
- Basic Auth.
- Windows Auth.
- LDAP Auth.
- Integration Svr. Auth.
- Off

❖ Enhanced Authentication Management

For details about this function, consult your administrator.

❖ Administrator Authentication Management

For details about this function, consult your administrator.

❖ Program / Change Administrator

For details about this function, consult your administrator.

❖ Key Counter Management

Specify the functions that you want to manage with the key counter.

- Copier: Full Colour / B&W
- Printer: B&W
- Other Functions: Document Server / Facsimile / Scanner

❖ Extended Security

Specify whether or not to use the extended security functions. For details about the extended security functions, consult your administrator.

❖ Auto Delete File in Document Server

Specify whether documents stored in the Document Server will or will not be deleted after a specified period of time.

- **On: 3 day(s)**
- Off

If you select **[On]**, documents stored subsequently are deleted after the specified period.

If you select **[Off]**, documents are not automatically deleted.

If you select **[On]**, enter a number of days from 1 to 180 (in 1 day increments). The default is 3 days, this means documents are deleted 3 days (72 hours) after they are stored.

❖ Delete All Files in Document Server

You can delete files stored in the Document Server, including files stored for Sample Print, Locked Print, Hold Print, and Stored Print under the printer function.

- No
- Yes

Even if a password is always set, all documents are deleted.

A confirmation message appears. To delete all documents, select **[Yes]**.

❖ Program / Change/Delete LDAP Server

Program the LDAP server to find up e-mail destinations in the LDAP server Address Book directly. This function is possible when sending scan files by e-mail using the scanner or fax function.

- Name
- Server Name
- Search Base
- Port Number
- SSL
- Authentication
- User Name
- Password
- Search Conditions
- Search Options

To start an LDAP search, make sure that the items listed below are set. For other items, check your environment and make any necessary changes.

- Server Name
- Search Base
- Port Number
- Search Conditions
- Authentication method selection

To use the LDAP server in Administrator Tools, select **[On]** under LDAP server. This function supports LDAP Version 2.0 and 3.0. Ver 2.0 does not support High Security authentication.

❖ LDAP Search

Specify whether or not to use the LDAP server for searching.

- On
- Off

If you select **[Off]**, LDAP server list will not appear on the searching display.

❖ AOF (Always On)

Specify whether or not to use Auto Off.

- On
- Off

❖ Firmware Version

You can check the version of the software installed in this machine.

❖ Network Security Level

For details about this function, consult your administrator.

❖ Auto Erase Memory Setting

For details about this function, consult your administrator.

❖ Erase All Memory

For details about this function, consult your administrator.

❖ Delete All Logs

For details about this function, consult your administrator.

❖ Transfer Log Setting

For details about this function, consult your administrator.

❖ Data Security for Copying

For details about this function, consult your administrator.

🔍 Reference

p.203 "Address Book"

p.217 "Printing the Counter for Each User"

p.277 "Counter"

Program / Change/Delete LDAP Server

This section explains how to specify the LDAP server settings.

To program/change the LDAP server

- 1** Press [System Settings].
- 2** Press [Administrator Tools].
- 3** Press [Program / Change / Delete LDAP Server].
- 4** Check that [Program / Change] is selected.
- 5** Select the LDAP server you want to program or change.
When programming the server, select [Not Programmed].
- 6** Set each item as necessary.
- 7** Press [OK] after setting each item.
For details about LDAP server, see "Programming the LDAP server".
- 8** Press [Exit].
- 9** Press the [User Tools/Counter] key.

 **Reference**

p.86 "Programming the LDAP server"

To delete the programmed LDAP server

- 1** Press [System Settings].
- 2** Press [Administrator Tools].
- 3** Press [Program / Change / Delete LDAP Server].
- 4** Press [Delete].
- 5** Select the LDAP server you want to delete.
- 6** Press [Yes].
- 7** Press [Exit].
- 8** Press the [User Tools/Counter] key.

Programming the LDAP server

This section explains how to specify the LDAP server settings.

To enter an identification name

2**1** Press [Change] under “Name”.

Register a name for the LDAP server that will appear on the server selection screen of the LDAP search operation.

2 Enter the server’s identification name.**3** Press [OK].

To enter a server name

1 Press [Change] under “Server Name”.

Register the LDAP server’s host name or IPv4 address.

2 Enter the LDAP server name.**3** Press [OK].

To enter the search base

1 Press [Change] under “Search Base”.

Select a route folder to start the search from e-mail addresses registered in the selected folder are search targets.

2 Enter the search base.

For example, if the search target is the sales department of ABC company, enter “dc=sales department, o=ABC”. (In this example, the description is for an active directory. “dc” is for the organization unit, and “o” is for the company.)

Search base registration may be required depending on your server environment. When registration is required, unspecified searches will result in error. Check your server environment and enter any required specifications.

3 Press [OK].

To enter a port number

1 Press [Change] under “Port No.”.

Specify the port number for communicating with the LDAP server. Specify a port that is compliant with your environment.

2 Enter the port number using the number keys, and then press the [#] key.

When SSL is set to [On], the port number automatically changes to “636”.

To start SSL communication

1 Press [On].

Use SSL to communicate with the LDAP server.

To use SSL, the LDAP server must support SSL.

When SSL is set to [On], the port number automatically changes to “689”.

SSL setting must be enabled on this machine. For details, consult your network administrator.

To set authentication

1 Press [▼Next].

2 Press [On] or [High Security] under “Authentication”.

To make a search request to the LDAP server, use the administrator account for authentication.

Authentication settings must comply with your server’s authentication settings. Check your server settings before setting this machine.

[High Security] is available only with LDAP Version 3.0.

When **[High Security]** is selected, the administrator password is encrypted before it is sent to the network. When **[On]** is selected, the password is sent without encryption.

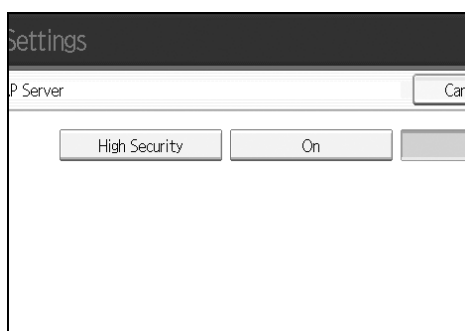

To enter the user name and password

1 Press [▼Next].

2 Press [Change] under “User Name”.

When [On] or [High Security] is selected for the authentication setting, use the administrator account name and password. Do not enter the administrator account name and password when using authentication for each individual or each search.

3 Enter the user name, and then press [OK].

Procedures for the user name setting differ depending on server environment. Check your server environment before making the setting.

Example: Domain Name\User Name, User Name@Domain Name, CN=Name, OU=Department Name, DC=Server Name

4 Press [Change] under “Password”.

5 Enter the password, and then press [OK].

The user name and password are required for administrator authentication to access the LDAP server.

You can set the user name and password in this machine’s Address Book to allow individual authentication access to the LDAP server. Use Administrator Tools to select the user name and password you want to use.

To test the connection

1 Press [Connection Test].

Access the LDAP server to check the proper connection is established. Check authentication works according to the authentication settings.

A connection test is carried out.

2 Press [Exit].

If the connection test fails, check your settings and try again.

This function does not check search conditions or the search base.

To set search conditions

1 Press [▼Next] twice.

2 Press [Change] for items you want to use as search conditions from the following: [Name], [E-mail Address], [Fax Number], [Company Name], and [Department Name].

You can enter an attribute as a typical search keyword. Using the entered attribute, the function searches the LDAP server's Address Book.

3 Enter the attribute you want to use when searching for e-mail addresses, and then press [OK].

The attribute value may change depending on the server environment. Check the attribute value complies with your server environment before setting it.

You can leave items blank, but you cannot leave attributes blank when searching for e-mail addresses from the LDAP server Address Book.

To set search options

1 Press [▼Next] three times.

2 Press [Change] under "Attribute".

3 Enter the attribute you want to use when searching for e-mail addresses, and then press [OK].

To search the LDAP server data using a keyword other than prepared keywords such as Name, E-mail Address, FAX Number, Company Name, and Department Name, specify the attribute for the keyword registered in your LDAP server, and the name to be displayed on the control panel during the search. For example, to search e-mail addresses by employee number, enter "employeeNo." in the Attribute field, and "Employee No." in the key display field.

The attribute value may change depending on the server environment. Check the attribute complies with your server environment before setting it.

4 Press [Change] under "Key Display".

5 Enter the key display, and then press [OK].

The registered “key display” appears as a keyword for searching LDAP.

- Without key display registration

Name	Beginning Word	End Word	Exact Match
Fax Destination	Beginning Word	End Word	Exact Match
E-mail Address	Beginning Word	End Word	Exact Match
Company Name	Beginning Word	End Word	Exact Match
Department Name	Beginning Word	End Word	Exact Match

- With key display registration

Name	Beginning Word	End Word	Exact Match
Fax Destination	Beginning Word	End Word	Exact Match
E-mail Address	Beginning Word	End Word	Exact Match
Company Name	Beginning Word	End Word	Exact Match
Department Name	Beginning Word	End Word	Exact Match
Employee No.	Beginning Word	End Word	Exact Match

The key does not appear on the search screen unless both “Attribute” and “Key Display” are registered. Make sure you register both to use the optional search.

3. Copier / Document Server Features

This chapter describes user tools in the Copier / Document Server Features menu. For details on how to access **[Copier / Document Server Features]**, see "Accessing User Tools (System Settings)".

Reference

p.3 "Accessing User Tools (System Settings)"

General Features

This section describes the user tools in the General Features menu under Copier / Document Server Features.

❖ Auto Image Density Priority

You can set whether Auto Image Density is "On" or "Off" when the machine is turned on, reset, or modes are cleared.

- Full Colour
 - On
 - **Off**
- B&W
 - On
 - Off

❖ Original Type Priority

You can select the original type effective when the power is turned on, or modes cleared.

- Full Colour
 - Text
 - **Text / Photo**
 - Photo
 - Pale
 - Generation Copy
 - Map
- B&W
 - Text
 - **Text / Photo**
 - Photo
 - Pale
 - Generation Copy
 - Map

❖ **Original Photo Type Priority**

When you select “Text / Photo” or “Photo” in “Original Type Priority”, you can change the settings of the selected original type.

- Glossy Photo
- **Printed Photo**
- Copied Photo

❖ **Original Type Display**

You can have the original types shown on the initial display.

- **Display**
- Hide

If you select **[Hide]**, the display is as below.

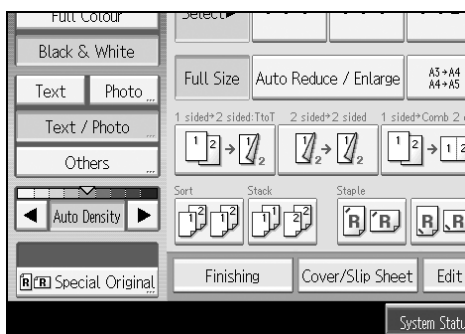

❖ **Paper Display**

You can choose to have the available paper trays and sizes shown on the initial display.

- **Display**
- Hide

If you select **[Hide]**, the display is shown as below. Press **[Auto Paper Select]** to display paper sizes.

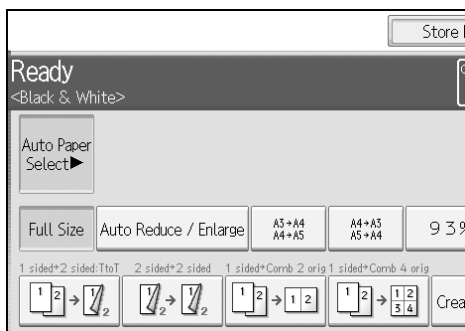

❖ **Original Orientation in Duplex Mode**

You can set the original orientation when making two-sided copies.

- **Top to Top**
- Top to Bottom

❖ Copy Orientation in Duplex Mode

You can set the copy orientation when making two-sided copies.

- Top to Top
- Top to Bottom

❖ Max. Copy Quantity

The maximum copy quantity can be set between 1 and 999.
The default setting is **999 sheets**.

❖ Auto Tray Switching

If you load paper of the same size in two or more trays, the machine automatically shifts to the other when the first tray runs out of paper (when Auto Paper Select is selected.) This function is called “Auto Tray Switching”. This setting specifies whether to use Auto Tray Switching or not.

- **With Image Rotation**
Use to copy when using the Auto Tray Switching function.
- Without Image Rotation
Only copies with Auto Tray Switching if you load paper of the same size and in the same orientation in two or more trays. If the paper is not the same size or in the same orientation, copying is interrupted and the message “Load paper.” is displayed.
- Off
When a paper tray runs out of paper, copying is interrupted and the message “Load paper.” is displayed.

❖ Tone: Original Remains

The beeper (key tone) sounds if you forget to remove originals after copying.

- On
- Off

If Panel Tone of User Tools (System Settings) is **[Off]** the beeper does not sound irrespective of the Tone: Original remains setting.

❖ Job End Call

You can choose whether or not the beeper sounds when copying is complete. If Panel Tone of User Tools (System Settings) settings is **[On]**, the machine beeps to notify you that it did not complete a job for reasons such as copying was interrupted, the paper tray ran out of paper, or a paper jam occurred.

- On
- Off

❖ Customize: Copier Function Key

You can assign up to six frequently-used functions to Copy Function keys.

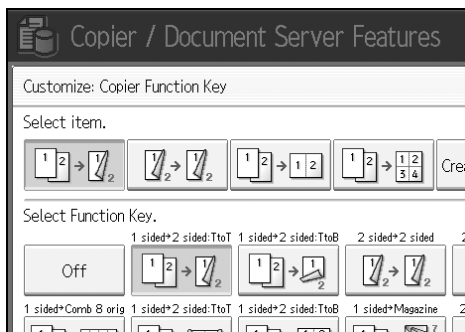

- Off
- 2 originals → 2 Sided: Top to Top
- 2 originals → 2 Sided: Top to Bottom
- 2 Sided → 2 Sided
- 2 Sided: Top to Top → 2 originals
- 1 Sided → 1 Sided Combine: 2 originals
- 1 Sided → 1 Sided Combine: 4 originals
- 1 Sided → 1 Sided Combine: 8 originals
- 4 originals → 2 Sided Combine: Top to Top
- 4 originals → 2 Sided Combine: Top to Bottom
- 1 Sided → Magazine
- 2 Sided → Magazine
- Create Margin
- Original Orientation
- Batch
- Staple: Top Slant/Left
- Staple: Bottom Slant/Left
- Staple: Left 2
- Staple: Top 2
- Staple: Top
- Staple: Bottom
- Saddle Stitch
- 2 Holes Left
- 2 Holes Top
- 3 Holes Left
- 3 Holes Top

- 4 Holes Left
- 4 Holes Top
- Positive/Negative

❖ **Customize: Document Server Storage key**

You can assign up to six frequently-used functions to Document Server Storage keys.

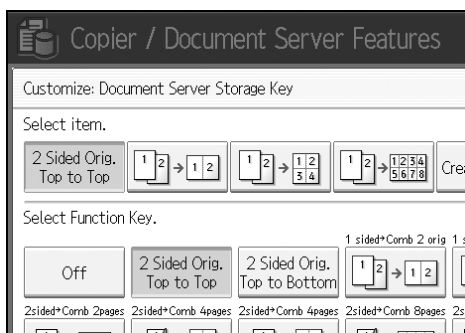

- Off
- 2 Sided original: Top to Top
- 2 Sided original: Top to Bottom
- 1 Sided → 1 Sided Combine: 2 originals
- 1 Sided → 1 Sided Combine: 4 originals
- 1 Sided → 1 Sided Combine: 8 originals
- 2 Sided: Top to Top → 1 Sided Combine: 2 originals
- 2 Sided: Top to Bottom → 1 Sided Combine: 2 originals
- 2 Sided: Top to Top → 1 Sided Combine: 4 originals
- 2 Sided: Top to Bottom → 1 Sided Combine: 4 originals
- 2 Sided: Top to Top → 1 Sided Combine: 8 originals
- 2 Sided: Top to Bottom → 1 Sided Combine: 8 originals
- Create Margin
- Original Orientation
- Batch
- Positive/Negative

🔍 **Reference**

p.49 "Panel Tone"

"Selecting the Original Type Setting", Copy/ Document Server Reference

"Adjusting Copy Image Density", Copy/ Document Server Reference

"Selecting Copy Paper", Copy/ Document Server Reference

Reproduction Ratio

This section describes the user tools in the Reproduction Ratio menu under Copier / Document Server Features.

❖ Shortcut R/E

You can register up to three frequently used Reduce / Enlarge ratios other than the fixed Reduce / Enlarge ratio and have them shown on the initial display. You can also change registered Reduce / Enlarge ratios.

- Metric version
 - 25%
 - A3 → A5, F → A5 (50%)
 - A3 → F (65%)
 - A3 → A4, A4 → A5 (71%)
 - B4 → F4 (75%)
 - F → A4, B4 → A4 (82%)
 - 93%
 - B4 → A3 (115%)
 - F → A3, A4 → B4 (122%)
 - A4 → A3, A5 → A4 (141%)
 - A5 → A3 (200%)
 - 400%
 - User R/E Ratio (25-400%)
 - Off
- Default:
 - **F1: 71%**
 - **F2: 141%**
 - **F3: 93%**
- Inch version
 - 25%
 - 11"×17" → 5¹/₂"×8¹/₂" (50%)
 - 11"×17" → 8¹/₂"×11" (65%)
 - 11"×15" → 8¹/₂"×11" (73%)
 - 8¹/₂"×14" → 8¹/₂"×11" (78%)
 - F → 8¹/₂"×11" (85%)
 - 93%

- $8\frac{1}{2}'' \times 14'' \rightarrow 11'' \times 17''$ (121%)
- $8\frac{1}{2}'' \times 11'' \rightarrow 11'' \times 17''$ (129%)
- $8\frac{1}{2}'' \times 8\frac{1}{2}'' \rightarrow 8\frac{1}{2}'' \times 14''$ (155%)
- $5\frac{1}{2}'' \times 8\frac{1}{2}'' \rightarrow 11'' \times 17''$ (200%)
- 400%
- User R/E Ratio (25-400%)
- Off

Default:

- **F1: 73%**
- **F2: 155%**
- **F3: 93%**

❖ Reproduction Ratio

Specify the enlargement and reduction ratios that appear if **[Reduce / Enlarge]** is pressed on the copier screen.

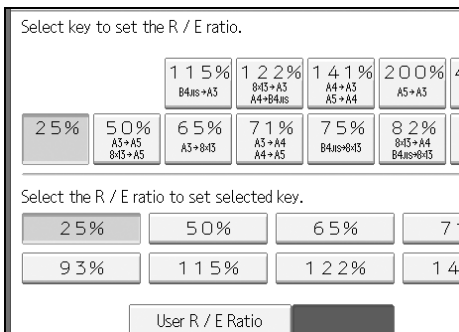

- Metric version
 - 25%
 - A3 → A5, F → A5 (50%)
 - A3 → F (65%)
 - A3 → A4, A4 → A5 (71%)
 - B4 → F4 (75%)
 - F → A4, B4 → A4 (82%)
 - 93%
 - B4 → A3 (115%)
 - F → A3, A4 → B4 (122%)
 - A4 → A3, A5 → A4 (141%)
 - A5 → A3 (200%)
 - 400%
 - User R/E Ratio (25-400%)

- Inch version
 - 25%
 - 11"×17" → 5¹/₂"×8¹/₂" (50%)
 - 11"×17" → 8¹/₂"×11" (65%)
 - 11"×15" → 8¹/₂"×11" (73%)
 - 8¹/₂"×14" → 8¹/₂"×11" (78%)
 - F → 8¹/₂"×11" (85%)
 - 93%
 - 8¹/₂"×14" → 11"×17" (121%)
 - 8¹/₂"×11" → 11"×17" (129%)
 - 8¹/₂"×8¹/₂" → 8¹/₂"×14" (155%)
 - 5¹/₂"×8¹/₂" → 11"×17" (200%)
 - 400%
 - User R/E Ratio (25-400%)

❖ R/E Ratio Priority

You can set the ratio with priority when **[Reduce / Enlarge]** is pressed.

- Metric version
 - 400%
 - 200%
 - 141%
 - 122%
 - 115%
 - 93%
 - 82%
 - 75%
 - **71%**
 - 65%
 - 50%
 - 25%

- Inch version
 - 400%
 - 200%
 - 155%
 - 129%
 - 121%
 - 93%
 - 85%
 - 78%
 - 73%
 - 65%
 - 50%
 - 25%

❖ **Ratio for Create Margin**

You can set a Reduce / Enlarge ratio when registering Create Margin in a shortcut key.

Enter a ratio using number keys (in the range of 90 to 99%).

The default setting is **93%**.

Edit

This section describes the user tools in the Edit menu under Copier / Document Server Features.

Enter the width of the binding margin with the number keys as follows:

- Metric version: 0–30 mm (in increments of 1 mm)
- Inch version: 0"-1.2" (in increments of 0.1 inch)

Enter the width of the erased margin with the number keys as follows:

- Metric version: 2–99 mm (in increments of 1 mm)
- Inch version: 0.1"-3.9" (in increments of 0.1 inch)

An image of approximately 1.5 mm (0.06") will not be displayed as the width of the separation line, when specifying solid or broken lines.

❖ Front Margin: Left/Right

Specify left and right margins on the front side of copies in Margin Adjustment mode.

- Left
- Right

Default:

- Metric version: **Left 5 mm**
- Inch version: **Left 0.2"**

❖ Back Margin: Left/Right

Specify left and right margins on the back side of copies in Margin Adjustment mode.

- Left
- Right

Default:

- Metric version: **Left 5 mm**
- Inch version: **Left 0.2"**

❖ Front Margin: Top/Bottom

Specify top and bottom margins on the front side of copies in Margin Adjustment mode.

- Top
- Bottom

Default:

- Metric version: **T / B: 0mm**
- Inch version: **T / B: 0.0"**

❖ **Back Margin: Top/Bottom**

Specify top and bottom margins on the back side of copies in Margin Adjustment mode.

- Top
- Bottom

Default:

- Metric version: **T / B: 0mm**
- Inch version: **T / B: 0.0"**

❖ **1 Sided → 2 Sided Auto Margin: TtoT**

In 1 sided to 2 sided Duplex mode, you can specify the margins on the back side. The margin is set to the same value of "Back Margin: Left/Right".

- Left
- **Right**

Default:

- Metric version: **Right 5 mm**
- Inch version: **Right 0.2"**

❖ **1 Sided → 2 Sided Auto Margin: TtoB**

In 1 sided to 2 sided Duplex mode, you can specify the margins on the back side. The value set for "Back Margin: Top/Bottom" is used.

- Top
- Bottom

Default:

- Metric version: **T / B: 0mm**
- Inch version: **T / B: 0.0"**

❖ **Erase Border Width**

Top/Bottom 0mm

Default:

- Metric version: **10mm**
- Inch version: **0.4"**

❖ **Erase Original Shadow in Combine**

In Combine mode, you can specify whether to erase a 3 mm, 0.1" boundary margin around all four edges of each original.

- **On**
- Off

❖ **Erase Centre Width**

Specify the width of the erased centre margins with this function.

Default:

- Metric version: **10 mm**
- Inch version: **0.4"**

❖ **Front Cover Copy in Combine**

You can make a combined copy on the front cover sheet when you select Front Cover mode.

Combine				Not Combined				
1	2	5	6	1	2	3	6	7
3	4	7	8		4	5	8	

GCST019E

- **Combine**
- Don not Combine

3

❖ **Copy Order in Combine**

You can set the copy order in Combine mode to Left to Right or Top to Bottom.

From Left to Right	From Top to Bottom																
<table border="1"> <tr><td>1</td><td>2</td></tr> <tr><td>3</td><td>4</td></tr> </table>	1	2	3	4	<table border="1"> <tr><td>1</td><td>3</td></tr> <tr><td>2</td><td>4</td></tr> </table>	1	3	2	4								
1	2																
3	4																
1	3																
2	4																
<table border="1"> <tr><td>1</td><td>2</td><td>3</td><td>4</td></tr> <tr><td>5</td><td>6</td><td>7</td><td>8</td></tr> </table>	1	2	3	4	5	6	7	8	<table border="1"> <tr><td>1</td><td>3</td><td>5</td><td>7</td></tr> <tr><td>2</td><td>4</td><td>6</td><td>8</td></tr> </table>	1	3	5	7	2	4	6	8
1	2	3	4														
5	6	7	8														
1	3	5	7														
2	4	6	8														

GCAH090E

- **From Left to Right**
- Form Right to Left
- Bottom Left
- Top to Bttm from RIGht

❖ **Orientation: Booklet, Magazine**

You can select the orientation of copies to open when using Booklet or Magazine mode.

- **Open to Left**
- Open to Right

❖ **Copy on Designating Page in Combine**

Specify whether to make a combined copy on the inserted slip sheets in Desig./Chapter mode.

- **Combine**
- Don not Combine

❖ Image Repeat Separation Line

You can select a separation line and colour using the Image Repeat function from: None, Solid, Broken A, Broken B, or Crop Marks.

- **None**



- **Solid**



- **Broken A**



- **Broken B**



- **Crop Marks**



Line colour (Full Colour):

- Yellow
- Red
- Cyan
- Magenta
- Green
- Blue
- **Black**

Separation lines cannot be specified when using **[None]**.

In "Black and White", printing will be done in black.

The image area of approximately 1.5 mm (0.06") wide on the separation line may not be copied, when specifying solid or broken lines.

❖ Double Copies Separation Line

You can select a separation line using the Double Copies function from: None, Solid, Broken A, Broken B, or Crop Marks.

- **None**



- **Solid**



- **Broken A**



- **Broken B**



- **Crop Marks**



Line colour (Full Colour):

- Yellow
- Red
- Cyan
- Magenta
- Green
- Blue
- **Black**

Separation lines cannot be specified when using **[None]**.

In "Black and White", printing will be done in black.

The image area of approximately 1.5 mm (0.06") wide on the separation line may not be copied, when specifying solid or broken lines.

❖ Separation Line in Combine

You can select a separation line using the Combine function from: None, Solid, Broken A, Broken B, or Crop Marks.

- **None**



- **Solid**



- **Broken A**



- **Broken B**



- **Crop Marks**



Line colour (Full Colour):

- Yellow
- Red
- Cyan
- Magenta
- Green
- Blue
- **Black**

Separation lines cannot be specified when using **[None]**.

In "Black and White", printing will be done in black.

The image area of approximately 1.5 mm (0.06") wide on the separation line may not be copied, when specifying solid or broken lines.

Reference

"Booklet/Magazine", Copy/ Document Server Reference

Stamp

This section describes the user tools in the Stamp menu under Copier / Document Server Features.

Background Numbering

This section describes the user tools in the Background Numbering menu under Stamp.

3

❖ **Size**

You can set the size of the numbers.

- Small
- **Normal**
- Large

❖ **Density**

You can set the density of the numbers.

- Light
- **Normal**
- Dark
- Very Dark

❖ **Stamp Colour**

You can set the colour of the numbers.

- Yellow
- Red
- Cyan
- Magenta
- Green
- Blue
- **Black**

Preset Stamp

This section describes the user tools in the Preset Stamp menu under Stamp.

❖ Stamp Language

You can select the language of the message printed in Stamp mode.

- English
- German
- French
- Italian
- Spanish
- Dutch
- Portuguese
- Polish
- Czech
- Swedish
- Finnish
- Hungarian
- Norwegian
- Danish
- Russian
- Japanese
- Simplified Chinese
- Traditional Chinese
- Hangul

❖ Stamp Priority

You can select the stamp type given priority when [**Preset Stamp**] is pressed.

- Copy
- URGENT
- PRIORITY
- For Your Info.
- PRELIMINARY
- For Internal Use Only
- CONFIDENTIAL
- DRAFT

❖ Stamp Format

Specify how each of stamp is printed.

- Stamp Position
Specify where to print the stamp.
 - Top Left
 - Top Centre
 - **Top Right**
 - Centre Left
 - Centre
 - Centre RIGht
 - Bottom Left
 - Bttm Centre
 - Bottom Right
- Stamp Position
You can adjust the position of the stamp within the available range as shown below.
 - Metric version:
 - "Top Left"...T/B: 4-144mm, L/R: 4-144mm
 - "Top Centre"...T/B: 4-144mm, L/R: 72-72mm
 - "Top Right"...T/B: 4-144mm, L/R: 4-144mm
 - "Centre Left"...T/B: 72-72mm, L/R: 4-144mm
 - "Centre"...T/B: 72-72mm, L/R: 72-72mm
 - "Centre Right"...T/B: 72-72mm, L/R: 4-144mm
 - "Bottom Left"...T/B: 4-144mm, L/R: 4-144mm
 - "Bttm Centre"...T/B: 4-144mm, L/R: 72-72mm
 - "Bottom Right"...T/B: 4-144mm, L/R: 4-144mm
 - Inch version:
 - "Top Left"...T/B: 0.1"-5.7", L/R: 0.1"-5.7"
 - "Top Centre"...T/B: 0.1"-5.7", L/R: 2.8"-2.8"
 - "Top Right"...T/B: 0.1"-5.7", L/R: 0.1"-5.7"
 - "Centre Left"...T/B: 2.8"-2.8", L/R: 0.1"-5.7"
 - "Centre"...T/B: 2.8"-2.8", L/R: 2.8"-2.8"
 - "Centre Right"...T/B: 2.8"-2.8", L/R: 0.1"-5.7"
 - "Bottom Left"...T/B: 0.1"-5.7", L/R: 0.1"-5.7"
 - "Bttm Centre"...T/B: 0.1"-5.7", L/R: 2.8"-2.8"
 - "Bottom Right"...T/B: 0.1"-5.7", L/R: 0.1"-5.7"
- Size
You can set the size of the stamp.
 - **1X**
 - **2X**

- **Density**
You can set the pattern used to print the stamp.
 - **Normal**
The stamp is printed on the image. You cannot check which parts will overlap.
 - **Lighter**
The image can be seen through the stamp.
 - **Lightest**
The image appears even clearer than in the Lighter setting.
- **Page to Stamp**
You can have the stamp printed on the first page or all pages.
 - **All Pages**
 - **1st Page Only**

❖ **Stamp Colour**

Sets the stamp print colour.

- Yellow
- **Red**
- Cyan
- Magenta
- Green
- Blue
- Black

Reference

"Preset Stamp", Copy/ Document Server Reference

User Stamp

This section describes the user tools in the User Stamp menu under Stamp.

❖ Program/Delete Stamp

You can register, change, or delete these designs as user stamps.

You can register up to four custom stamps with your favourite designs.

❖ Stamp Format:1-4

Specify how each of registered User Stamps 1 to 4 is printed.

• Stamp Position

Specify where to print the User Stamp.

- Top Left
- Top Centre
- **Top Right**
- Centre Left
- Centre
- Centre Right
- Bottom Left
- Bttm Centre
- Bottom Right

• Stamp Position

You can adjust the position of the User Stamp within the available range as shown below.

• Metric version:

"Top Left"...T/B: 4-144mm, L/R: 4-144mm
 "Top Centre"...T/B: 4-144mm, L/R: 72-72mm
 "Top Right"...T/B: 4-144mm, L/R: 4-144mm
 "Centre Left"...T/B: 72-72mm, L/R: 4-144mm
 "Centre"...T/B: 72-72mm, L/R: 72-72mm
 "Centre Right"...T/B: 72-72mm, L/R: 4-144mm
 "Bottom Left"...T/B: 4-144mm, L/R: 4-144mm
 "Bttm Centre"...T/B: 4-144mm, L/R: 72-72mm
 "Bottom Right"...T/B: 4-144mm, L/R: 4-144mm

• Inch version:

"Top Left"...T/B: 0.1"-5.7", L/R: 0.1"-5.7"
 "Top Centre"...T/B: 0.1"-5.7", L/R: 2.8"-2.8"
 "Top Right"...T/B: 0.1"-5.7", L/R: 0.1"-5.7"
 "Centre Left"...T/B: 2.8"-2.8", L/R: 0.1"-5.7"
 "Centre"...T/B: 2.8"-2.8", L/R: 2.8"-2.8"
 "Centre Right"...T/B: 2.8"-2.8", L/R: 0.1"-5.7"
 "Bottom Left"...T/B: 0.1"-5.7", L/R: 0.1"-5.7"
 "Bttm Centre"...T/B: 0.1"-5.7", L/R: 2.8"-2.8"
 "Bottom Right"...T/B: 0.1"-5.7", L/R: 0.1"-5.7"

- Page to Stamp
Sets whether to print the stamp on all pages or only the first page.
 - **All Pages**
 - 1st Page Only

❖ **Stamp Colour:1-4**

Sets the colour registered in User Stamp colour (1 to 4).

- Yellow
- Red
- Cyan
- Magenta
- Green
- Blue
- **Black**

Reference

"User Stamp", Copy/Document Server Reference

Date Stamp

This section describes the user tools in the Date Stamp menu under Stamp.

❖ **Format**

You can select the date format for Date Stamp mode.

- MM / DD / YYYY
- MM.DD.YYYY
- DD / MM / YYYY
- DD.MM.YYYY
- YYYY.MM.DD

Default:

- Metric version: **DD / MM / YYYY**
- Inch version: **MM / DD / YYYY**

❖ **Font**

You can select the Date Stamp font.

- **Font 1**
- Font 2
- Font 3

❖ Size

You can set the Date Stamp size.

- **Auto**
- Large
- Middle
- Small

❖ Superimpose

You can have the Date Stamp printed in white when it overlaps black parts of the image.

- On
- **Off**

❖ Stamp Colour

You can set the selected priority colour when printing the date.

- Yellow
- Red
- Cyan
- Magenta
- Green
- Blue
- **Black**

❖ Stamp Setting

Specify how Date Stamp is printed.

- Stamp Position
Specify where to print the Date Stamp.
 - **Top Left**
 - Top Centre
 - Top Right
 - Bottom Left
 - Bttm Centre
 - Bottom Right

- Stamp Position

You can adjust the position of the Date Stamp within the available range as shown below.

- Metric version:
 - "Top Left"...T/B: 4-144mm, L/R: 4-144mm
 - "Top Centre"...T/B: 4-144mm, L/R: 72-72mm
 - "Top Right"...T/B: 4-144mm, L/R: 4-144mm
 - "Bottom Left"...T/B: 4-144mm, L/R: 4-144mm
 - "Bttm Centre"...T/B: 4-144mm, L/R: 72-72mm
 - "Bottom Right"...T/B: 4-144mm, L/R: 4-144mm

- Inch version:
 - "Top Left"...T/B: 0.1"-5.7", L/R: 0.1"-5.7"
 - "Top Centre"...T/B: 0.1"-5.7", L/R: 2.8"-2.8"
 - "Top Right"...T/B: 0.1"-5.7", L/R: 0.1"-5.7"
 - "Bottom Left"...T/B: 0.1"-5.7", L/R: 0.1"-5.7"
 - "Bttm Centre"...T/B: 0.1"-5.7", L/R: 2.8"-2.8"
 - "Bottom Right"...T/B: 0.1"-5.7", L/R: 0.1"-5.7"
- Page to Stamp
 - Sets whether to print the stamp on all pages or only the first page.
- All Pages
- 1st Page Only

Page Numbering

This section describes the user tools in the Page Numbering menu under Stamp.

❖ Stamp Format

You can select the page number format given priority when **[Page Numbering]** is pressed.

- P1,P2...
- 1/5,2/5...
- -1-,-2-...
- P.1,P.2...
- 1,2...
- 1-1,1-2...

❖ Font

You can select the page number printed in Page Numbering mode.

- Font 1
- Font 2
- Font 3

❖ Size

You can set the size of the stamp printed in Page Numbering mode.

- Auto
- Large
- Middle
- Small

❖ Duplex Back Page Stamping Position

You can set the position of the duplex back page number printed in Duplex mode.

- Opposite Position
- Same Position

❖ **Page Numbering in Combine**

You can set page numbering when using the Combine function and the Page Numbering function together.

- **Per Original**
- Per Copy

❖ **Stamp Position on Designating Page**

You can select to print the page number onto slip sheets when using the Designate function set to **[Copy]** and the Page Numbering function together.

- On
- **Off**

❖ **Stamp Position**

Specify how each of stamp is printed.

- Stamp Position
Specify where to print the stamp.
 - Top Left
 - Top Centre
 - **Top Right**
 - Bottom Left
 - Bttm Centre
 - Bottom Right
- Stamp Position
You can adjust the position of the stam within the available range as shown below.
 - Metric version:
 - "Top Left"...T/B: 4-144mm, L/R: 4-144mm
 - "Top Centre"...T/B: 4-144mm, L/R: 72-72mm
 - "Top Right"...T/B: 4-144mm, L/R: 4-144mm
 - "Bottom Left"...T/B: 4-144mm, L/R: 4-144mm
 - "Bttm Centre"...T/B: 4-144mm, L/R: 72-72mm
 - "Bottom Right"...T/B: 4-144mm, L/R: 4-144mm
 - Inch version:
 - "Top Left"...T/B: 0.1"-5.7", L/R: 0.1"-5.7"
 - "Top Centre"...T/B: 0.1"-5.7", L/R: 2.8"-2.8"
 - "Top Right"...T/B: 0.1"-5.7", L/R: 0.1"-5.7"
 - "Bottom Left"...T/B: 0.1"-5.7", L/R: 0.1"-5.7"
 - "Bttm Centre"...T/B: 0.1"-5.7", L/R: 2.8"-2.8"
 - "Bottom Right"...T/B: 0.1"-5.7", L/R: 0.1"-5.7"

❖ **Superimpose**

You can have page numbers printed in white when they overlap black parts of the image.

- On
- **Off**

❖ **Stamp Colour**

You can set the selected priority colour when printing the date.

- Yellow
- Red
- Cyan
- Magenta
- Green
- Blue
- **Black**

❖ **Page Numbering Initial Letter**

You can select the page numbering initial letter between "P1, P2.../P.1, P.2..." and "S1, S2.../S.1, S.2...".

- **P1, P2.../P.1, P.2...**
- S1, S2.../S.1, S.2...

Input/Output

This section describes the user tools in the Input/Output menu under Copier / Document Server Features.

❖ Switch to Batch

You can select to have Batch mode or SADF mode displayed when you press the **[Special Original]** key.

- **Batch**
- **SADF**

❖ SADF Auto Reset

In SADF mode, an original must be set within a specified time after the previous original has been fed.

You can adjust this time from 3 to 99 seconds in increments of 1 second.

The default setting is **5 second(s)**.

❖ Rotate Sort: Auto Paper Continue

Specify to continue copying when paper of the required orientation has run out during rotatesorting.

- **On**
Copying continues using copy paper of a different orientation. The copy job will finish even if you have left the machine.
- **Off**
When paper of the required orientation runs out, the machine stops copying and prompts you to supply copy paper. After you have loaded paper, the machine will continue copying.

❖ Memory Full Auto Scan Restart

When memory becomes full while scanning originals, the machine can make copies of scanned originals first, and then automatically proceed scanning remaining originals.

- **On**
You can leave the machine unattended to make copies, but sorted pages will not be sequential.
- **Off**
When memory becomes full, the machine stops operation allowing you to remove the copy pages delivered on the output tray.

❖ Letterhead Setting

If you select **[Yes]** in this function, the machine rotates the image correctly.

- **Yes**
- **No**

Orientation-fixed (top to bottom) or two-sided paper might not be printed correctly depending on how the originals and paper are placed.

❖ Select Stapling Position

Specify which Top 2 staples or Bottom shown on the initial display with priority.

The optional 500-sheet finisher, 1000-sheet finisher, or booklet finisher is required to use this function.

- Top Slant/Left
- Bottom Slant/Left
- Lett 2
- Top 2
- Top
- Bottom
- Saddle Stitch
- Off

❖ Select Punch Type

Specify which punch type (2 holes or 3 holes) has priority to be shown on the initial display.

The optional 500-sheet finisher, 1000-sheet finisher, or booklet finisher is required to use this function.

- 2 Holes Left
- 2 Holes top
- 3 Holes left
- 3 Holes Top
- 4 Holes Left
- 4 Holes Top
- Off

❖ **Simplified Screen: Finishing Types**

You can select which key is displayed with higher priority for “Finishing Types” on the Simplified Screen.

- Stack
- Staple: Top
- Staple: Slant
- Staple: Bottom
- Staple: Left 2
- 2 Holes Left
- 3 Holes Left
- 4 Holes Left
- Do not Display

Reference

"Orientation-Fixed Paper or Two-Sided Paper", Troubleshooting

"Batch mode", Copy / Document Server Reference

"Sort", Copy / Document Server Reference

Adjust Colour Image

This section describes the user tools in the Adjust Colour Image menu under Copier / Document Server Features.

❖ ADS Background (Full Colour)

"The background density is adjusted to skip the texture and copy. You can adjust the background density up to 5 levels when in Full Colour.

Centre of the 5 level adjustment is set by default.

❖ Colour Sensitivity

You can adjust the colour specified to convert in "Colour Convert" and the colour specified for "Erase Colour", in 5 levels.

Centre of the 5 level adjustment is set by default.

When the colour width has been set to "Wider", and the colour to be deleted, for example is red, all the colours that are close to magenta and orange are deleted. If it's set to "Narrower" the colour red will be deleted.

❖ A.C.S. Sensitivity

This 5-step setting determines the level of the standard used for discriminating between black & white originals and full colour originals when "Auto Colour Select" is selected.

Centre of the 5 level adjustment is set by default.

❖ A.C.S. Priority

This setting determines the copy priority between "Black & White" and "Full Colour" when "Auto Colour Select" is selected.

- **Full Colour**
- Black & White

Settings for the Document Server

For details, see "System Settings", and "Copier / Document Server Features".

❖ Copier / Document Server Features

Heading	items	Default
General Features	Document Server Storage key	2 Sided Original
General Features	Document Server Storage key	1 sided→Comb 2 orig
General Features	Document Server Storage key	1 sided→Comb 4 orig
General Features	Document Server Storage key	1 sided→Comb 8 orig
General Features	Document Server Storage key	Create Margin
General Features	Document Server Storage key	Off

❖ System Settings

Heading	Item	Default
General Features	Warm Up Notice	On
General Features	Copy Count Display	Up
General Features	Output: Document Server	Internal Tray 1
Tray Paper Settings	Paper Tray Priority: Copier	Tray 1
Tray Paper Settings	Cover Sheet Tray	Off
Tray Paper Settings	Slip Sheet Tray	Off
Timer Settings	Copier/Document Server Auto Reset Timer	60 second(s)
Administrator Tools	Auto Delete File in Document Server	3 day(s)
Administrator Tools	Delete All Files in Document Server	-

Reference

p.91 "Copier / Document Server Features"

p.49 "System Settings"

4. Facsimile Features

This chapter describes user tools in the Facsimile Features menu.

For details on how to access **[Facsimile Features]**, see "Accessing User Tools (System Settings)".

Reference

p.3 "Accessing User Tools (System Settings)"

General Features

This section describes the user tools in the General Features menu under Facsimile Features.

❖ Quick Operation Key (1-3)

Frequently used functions programmed as Quick Operation keys are shown on the menu immediately after the power is turned on.

If **[On]** is selected, the Quick Operation keys can be programmed with the following items:

- On
 - Manual E-mail RX
 - PIN Code TX
 - Send Later
 - Subject
 - Text
 - Recept. Notice
 - Std. Message
 - Fax Header Print
 - Label Insertion
 - Closed Network
 - E-mail TX Results
 - Print Memory Lock
 - Stamp
 - TX File Status
 - RX File Status
 - Journal
 - Print Stored RX File
 - TX Status Report
 - Forwarding
 - Switch RX Mode

- SUB Code TX
- SEP Code Reception
- BCC Transmission
- Off

Up to three functions can be programmed to a Quick Operation keys. Functions that appear dimmed have already been set.

❖ **Switch Title of Quick Dial Table**

Select the title to be shown on the destination list.

- Title 1
- Title 2
- Title 3

4

❖ **Search Destination**

Select a destination list to be used in "Search Destination". You can select from Address Book, or registered LDAP Server.

❖ **Communication Page Count**

Checks the transmission and reception, and totals on the display.

- Transmissions:
Total number of transmitted pages
- Receptions:
Total number of received pages

- ① Press [**Facsimile Features**].
- ② Press [**General Features**].
- ③ Press [**Communication Page Count**].
- ④ After checking the display, press [**Exit**].
- ⑤ Press the [**User Tools/Counter**] key.

❖ **Adjust Sound Volume**

Adjust the sound volume during On Hook Mode and Immediate Transmission.

- On Hook Mode
- At Transmission
- At Reception
- At Dialing
- At Printing

❖ **Box Setting**

The following functions are for delivery and transfer of documents:

- Personal Box
- Information Box
- Transfer Box

For details about Box Setting, see "Box Settings"

❖ Box Setting: Print List

You can print a list of the Personal Boxes, Information Boxes, and Transfer Boxes currently programmed.

❖ On Hook Mode Release Time

Use this function to specify a time to cancel On Hook mode after you transmit using On Hook dialing.

- 1 minute
- 3 minutes
- 5 minutes
- 10 minutes

 Reference

p.170 "Box Settings"

"Adjusting the Volume", Troubleshooting

"Sending at a Specific Time (Send Later)", Facsimile Reference

"Fax Header Print", Facsimile Reference

"Reading the Display", Facsimile Reference

Scan Settings

This section describes the user tools in the Scan Settings menu under Facsimile Features.

❖ **Program / Change / Delete Scan Size**

You can program, change, or cancel frequently used scan sizes.

For details about programming Scan Size, see "Program / Change / Delete Scan Size".

Reference

p.141 "Program / Change / Delete Scan Size"

Send Settings

This section describes the user tools in the Send Settings menu under Facsimile Features.

❖ Max. E-mail Size

Specify to limit the size of e-mail messages that are transmitted, if receivers limit e-mail size, or you cannot send large size e-mail for some reason. When this function is set to on, transmission of e-mail that exceeds the set size is aborted.

- On
- Off

When e-mail exceeds the maximum file size, an Error Report is output, and the e-mail is deleted.

Even when e-mail does not exceed the size limit, it may be rejected if it does not meet the requirements of the server settings.

- ① Press **[Facsimile Features]**.
- ② Press **[Send Settings]**.
- ③ Press **[Max. E-mail Size]**.
- ④ Press **[On]**.

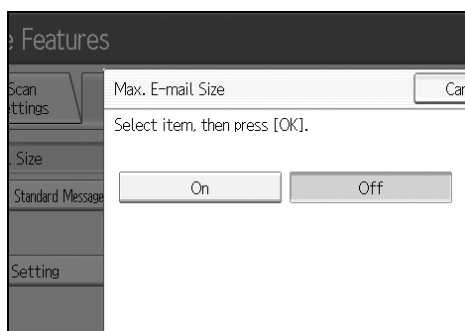

- ⑤ Enter the maximum e-mail size using the number keys.

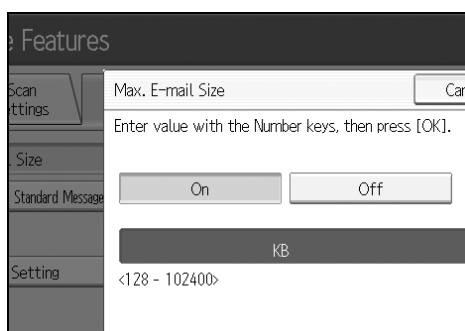

Maximum e-mail size can be between 128 and 102,400 KB.

If you make a mistake, press **[Clear]** or the **[Clear/Stop]** key, and then enter again.

- ⑥ Press **[OK]**.

❖ Program / Change / Delete Standard Message

Program standard messages to be printed at the top of the first page of the original of the opposite party. It is useful for personalizing messages such as sending greetings.

You can program three standard messages. You cannot change the "Confidential", "Urgent", "Please phone.", or "Copy to corres. section" messages. The procedure is the same for both programming and changing.

- ① Press **[Facsimile Features]**.
- ② Press **[Send Settings]**.
- ③ Press **[Program / Change / Delete Standard Message]**.
- ④ Check that **[Program / Change]** is selected.
To delete the registered message, press **[Delete]**.

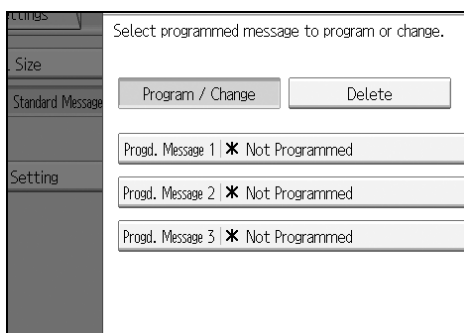

- ⑤ Select the message you want to program or change.
To delete the registered message, select the message you want to delete, and then press **[Yes]**.
- ⑥ Enter a new message.
For details about entering text, see "Entering Text", About This Machine.
- ⑦ Press **[OK]**.
To cancel a registration, press **[Cancel]**.
- ⑧ Press **[Exit]**.
- ⑨ Press the **[User Tools/Counter]** key.

❖ Backup File TX Setting

You can specify whether or not to send to a selected folder the backup of a file sent by Memory Transmission.

By setting **[Backup File TX Setting]** to **[On]** and selecting the destination folder, you can automatically send to the selected folder the backup of a file sent by Memory Transmission using the machine's control panel, Web Image Monitor, DeskTopBinder, or LAN-Fax.

Select the destination folder for the backup file from the address book.

- On
- Off

If you set **[Backup File TX Setting]** to **[On]** but the Backup File TX fails, the machine automatically prints a backup file TX communication failure report. For details about the communication failure report, see "Communication failure report", Facsimile Reference.

Using the parameter settings (switch 04, bit 1), specify whether or not to print a communication failure report.

The backup file format will be the same as that specified for files sent by Scan to Folder. Using the parameter settings (switch: 21, bit: 3), select TIFF or PDF as the format for sending a file. The format is factory-preset to TIFF. Using the parameter settings, you can specify the redial interval (switch 35, bits 0-7) and the maximum number of redials (switch 36, bits 0-7). The redial interval is factory-preset to 15 minutes; the maximum number of redials, to 192.

Using the parameter settings, (switch 37, bit 0) you can specify whether to stop sending a backup file if the destination folder becomes full while the machine is sending or waiting to send a fax or the backup file.

- ① Press **[Facsimile Features]**.
- ② Press **[Send Settings]**.
- ③ Press **[Backup File TX Setting]**.
- ④ Press **[On]**.

If there is a folder already programmed, a folder name is shown. If you want to change the folder, press **[Folder]** and proceed to step ⑤.

- ⑤ Specify a folder for back up, and then press **[OK]**.
The folder name is shown to the right of **[Folder]**.
- ⑥ Press **[OK]**.
- ⑦ Press the **[User Tools/Counter]** key.

Reference

p.151 "Parameter Settings"

"Entering Text", About This Machine

"Communication failure report", Facsimile Reference

"Maximum Values", Facsimile Reference

Reception Settings

This section describes the user tools in the Reception Settings menu under Facsimile Features.

❖ **Switch Reception Mode**

Specify the method for receiving fax documents.

- Manual Reception
- Auto Reception

❖ **Program Special Sender**

By programming particular receivers as Special Sender in advance, you can have Special Senders treated differently.

For details about how to program Special Sender, see "Special Senders to Treat Differently".

❖ **Program Special Sender: Print List**

You can print the Special Sender List.

- ① Press **[Facsimile Features]**.
- ② Press **[Reception Settings]**.
- ③ Press **[Program Special Sender: Print List]**.
- ④ Press the **[Start]** key.
To cancel printing a list before pressing the **[Start]** key, press **[Cancel]** or the **[Clear/Stop]** key.
- ⑤ Press the **[User Tools/Counter]** key.

❖ **Forwarding**

Specify whether or not received fax documents are to be forwarded to a programmed receiver.

- On
- Off

❖ **Reception File Setting**

Selects whether received documents are saved on the hard disk to be printed later or printed immediately without being saved.

For details about Reception File Setting, see "Reception File Setting".

❖ **Stored Reception File User Setting**

The administrator can be specified for managing documents stored on the machine after fax documents are received. To specify the administrator, enter the administrator user code for managing documents using Web Image Monitor or DeskTopBinder.

You must register the administrator's User Code to the destination list in advance.

This function is only available when **[Store]** is selected in "Reception File Setting".

It is recommended that you use a Web Image Monitor operating under the same network environment as this machine. Otherwise, the Web browser may not open and an error may occur.

- ① Press **[Facsimile Features]**.
- ② Press **[Reception Settings]**.
- ③ Press **[Stored Reception File User Setting]**.
- ④ If you want to use a user code, press **[On]**.
- ⑤ Press the Destination key of the user you wish to specify, and then press **[OK]**.
- ⑥ Check the selected user, and then press **[OK]**.

When a programmed user is deleted from the destination list, message "Deleted from Address Book" is displayed. Enter the user again.

- ⑦ Press the **[User Tools/Counter]** key.

If the programmed user code was deleted using the Address Book Management function under System Settings, you cannot view received and saved documents using a Web Image Monitor. Select **[Off]** in step ④ or reprogram the user code.

❖ **SMTP Reception File Delivery Settings**

This function is available on systems that allow routing of e-mail received via SMTP.

- On
- Off

When an authorized e-mail address is set, e-mail received from addresses that do not match the authorized address is discarded, and an error message is returned to the SMTP server.

The authorized e-mail address is compared with the addresses of email originators, as illustrated by the following examples.

- When the authorized e-mail address is set to "@aaa.abcd.com":
 abc@aaa.abcd.com - accepted
 def@aaa.xyz.com - not accepted
 abc@abcd.com - not accepted

No Error Report is output even when e-mail is discarded.

① Press **[On]**.

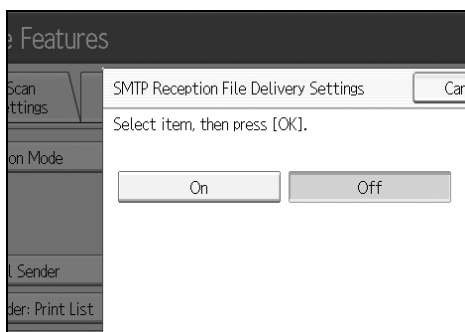

② Press **[Change]**, and then enter the sending e-mail address to be authorized.

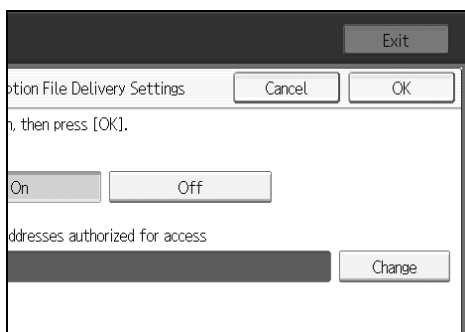

If you make a mistake, press **[Backspace]** or **[Clear]**, and then enter again.

③ Press **[OK]** twice.

❖ **2 Sided Print**

Specify whether or not received fax documents are to be printed on both sides of the paper.

- On
- Off

❖ **Checkered Mark**

Specify whether or not a checkered mark is to be printed on the first page of received fax documents.

- On
- Off

❖ **Centre Mark**

Specify whether or not a centre mark is to be printed halfway down the left side and at the top centre of each page received.

- On
- Off

❖ Print Reception Time

Specify whether or not the received date, time, and file number are printed at the bottom of received fax documents.

- On
- Off

❖ Reception File Print Quantity

Specify the number of copies to be printed for each fax document received.

- 1 to 10 set(s)

❖ Paper Tray

Use this function to print fax documents received from programmed senders and fax documents from other senders, using different paper trays. Display of tray names may differ depending on the options installed.

- Tray 1
- Tray 2
- Tray 3 (option)
- Tray 4 (option)
- LCT (option)
- Auto Select

❖ Specify Tray for Lines

Specify a paper tray for each line (telephone, Internet Fax, IP-Fax).

- Off
- On

① Press **[Facsimile Features]**.

② Press **[Reception Settings]**.

③ Press **[Specify Tray for Lines]**, and then press **[▼Next]**.

④ Press **[On]**.

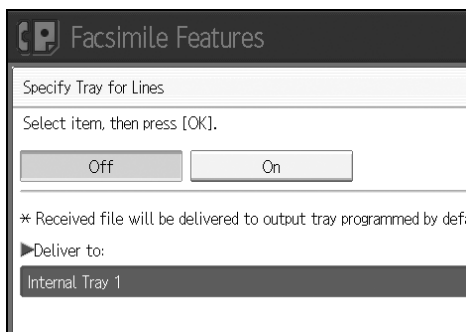

If you select **[Off]**, the received fax is delivered to a default tray.

- ⑤ Select the line type.

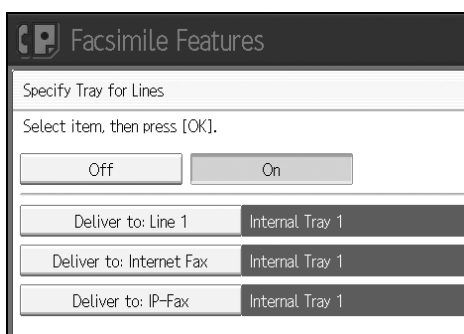

- ⑥ Select a tray to deliver the received paper onto, and then press **[OK]**.
If you want to specify another line type, repeat from step ⑤.

4

❖ Folder Transfer Result Report

You can set whether the Folder Transfer Result Report is transmitted to the specified e-mail address, when folders are programmed as the forwarding destinations to which documents are sent from all senders or Special Senders. You must first register the destination for the Folder Transfer Result Report in the destination list. See "Registering a Fax Destination".

Specify a group destination to transfer documents to multiple destinations. A maximum of 500 parties can be specified in a group. See "Registering Names to a Group".

Even if the Folder Transfer Result Report is not successfully transmitted, the report is not printed on this machine.

- E-mail
- Do not E-mail

- ① Press **[Facsimile Features]**.
- ② Press **[Reception Settings]**.
- ③ Press **[▼Next]**.
- ④ Press **[Folder Transfer Result Report]**.
- ⑤ To send the Folder Transfer Result Report, press **[E-mail]**.
To not send the Folder Transfer Result Report, press **[Do not E-mail]**, and then press **[OK]**.
- ⑥ Press **[Notify Destination]**.
- ⑦ Press the Destination key of the email address for notification, and then press **[OK]**.
- ⑧ Check the selected destination, and then press **[OK]**.
- ⑨ Press the **[User Tools/Counter]** key.

❖ Memory Lock Reception

When you switch Memory Lock on, received documents are stored in memory and not printed automatically. When a document is received in the Memory Lock mode, the Confidential File indicator blinks. To print this document, enter the Memory Lock ID. A user without the ID cannot print the document. This prevents unauthorized users from accessing the document. To use Memory Lock, program the Memory Lock ID, and then switch Memory Lock on. To store incoming documents from Special Senders only in Memory Lock, program each sender with "Special Senders to Treat Differently". This function is not available with Internet Fax.

- ① Press [**Facsimile Features**].
- ② Press [**Reception Settings**], and then press [**▼Next**].
- ③ Press [**▼Next**].
- ④ Press [**Memory Lock Reception**].
- ⑤ Select [**On**] or [**Off**], and then press [**OK**].
- ⑥ Press the [**User Tools/Counter**] key.

🔍 Reference

- p.139 "Reception File Setting"
- p.51 "Output: Facsimile (facsimile)"
- p.158 "Special Senders to Treat Differently"
- p.135 "Program Memory Lock ID"
- p.223 "Registering a Fax Destination"
- p.255 "Registering Names to a Group"

Initial Settings

This section describes the user tools in the Initial Settings menu under Facsimile Features.

❖ Parameter Setting

User Parameters allow you to customize various settings to suit your needs. For details about Parameter Setting, see "Parameter Settings".

❖ Parameter Setting: Print List

You can print Parameter Setting list.

Print this list to see the current User Parameter settings. However, not all the parameter settings are printed.

① Press **[Facsimile Features]**.

② Press **[Initial Settings]**.

③ Press **[Parameter Setting: Print List]**.

④ Press the **[Start]** key.

To cancel printing a list before pressing the **[Start]** key, press **[Cancel]** or the **[Clear/Stop]** key.

⑤ Press the **[User Tools/Counter]** key.

❖ Program Closed Network Code

Register an ID required for Closed Network communication.

① Press **[Facsimile Features]**.

② Press **[Initial Settings]**.

③ Press **[Program Closed Network Code]**.

④ Enter an ID using the number keys and **[A]** to **[F]**, and then press **[OK]**.

Register a four-digit number using 0 through 9 and A through F (except for 0000 and FFFF).

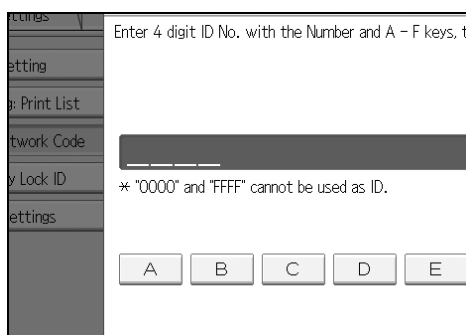

⑤ Press the **[User Tools/Counter]** key.

❖ Program Memory Lock ID

Program a Memory Lock ID to be entered before printing documents when the Memory Lock function is activated.

- ① Press **[Facsimile Features]**.
- ② Press **[Initial Settings]**.
- ③ Press **[Program Memory Lock ID]**.
- ④ Enter an ID using the number keys, and then press **[OK]**.
A Memory Lock ID can be any four-digit number, except 0000.

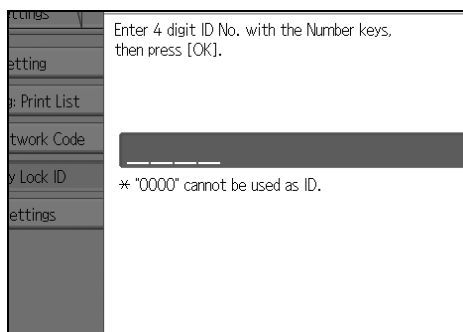

If you make a mistake, press **[Clear]** or the **[Clear/Stop]** key before pressing **[OK]**, and then try again.

- ⑤ Press the **[User Tools/Counter]** key.

❖ Internet Fax Settings

You can select to display the internet Fax icon or not. When you want to send an Internet Fax, set On to display the icon.

- On
- Off

❖ Select Dial / Push Phone

Use this function to select a line type when the machine is connected to a G3 analog line.

Dial and Push lines are available for selection.

If the optional extra G3 interface unit is installed, settings for the extra G3 lines appear.

This function is not available in some regions.

- ① Press **[Facsimile Features]**.
- ② Press **[Initial Settings]**.
- ③ Press **[Select Dial / Push Phone]**.
- ④ Press **[Push Button Phone]** or **[Dial Phone (10PPS)]** to select the line, and then press **[OK]**.
- ⑤ Press the **[User Tools/Counter]** key.

❖ Program Fax Information

Program information to be shown on the display of the other machine and printed as a report. The following information can be programmed.

- Fax Header
- Own Name
- Own Fax Number

For details about how to program Fax Information, see "Registering Fax Information"

❖ Enable H.323

Specify whether or not H.323 is used for IP-Fax transmission.

- On
- Off

❖ Enable SIP

Specify whether or not SIP is used for IP-Fax transmission.

- On
- Off

❖ H.323 Settings

Set the IPv4 address or host name, and alias telephone number of the gatekeeper.

If you select **[On]** using the User Parameters, you can use the gatekeeper server. See "Parameter Settings" (switch 34, bit 0).

You can use numbers, and symbols ("#" and "*") for registration of the alias telephone number in H.323 Settings. Make sure you enter these characters correctly.

- ① Press **[Facsimile Features]**.
- ② Press **[Initial Settings]**.
- ③ Press **[H.323 Settings]**.
- ④ Press **[Change]** for each property.
- ⑤ Enter the IPv4 address or host name, and alias telephone number and press **[OK]**.
- ⑥ Press **[OK]**.

❖ SIP Settings

Set the SIP server's IPv4 address or host name, and SIP user name.

If you select **[On]** using the User Parameters, you can use the SIP server. See "Parameter Settings" (switch 34, bit 1).

You can use alphanumeric symbols (lower and upper cases) and symbols (";", "?", ":", "&", "=", "+", "\$", ",", "-", "_", ".", "!", "~", "*", "#", "/", "(", ")", "%", "/", and "@") for registration of the SIP User Name in SIP Settings. Make sure you enter these characters correctly.

Use numbers and periods (".") to enter the correct IPv4 addresses for the gate-keeper, SIP server, and gateway. To obtain the correct IPv4 addresses, consult the administrator.

① Press **[Facsimile Features]**.

② Press **[Initial Settings]**.

③ Press **[SIP Settings]**.

④ Press **[Change]** for each property.

A proxy server relays call requests and responses.

A redirect server processes request destination inquiries.

A register server registers location information of user agents (which correspond to telephones or facsimiles on public telephone lines) on an IP network.

⑤ Enter the IPv4 address or host name, and SIP user name, and then press **[OK]**.

⑥ Specify whether to perform SIP digest authentication.

If you select **[On]**, enter the password using up to 128 characters.

⑦ Press **[OK]**.

❖ Program / Change / Delete Gateway

Register, change, or delete the gateway used for transmission to IP-Fax.

- Program / Change

① Press **[Facsimile Features]**.

② Press **[Initial Settings]**.

③ Press **[Program / Change / Delete Gateway]**.

④ Check that **[Program / Change]** is selected.

⑤ Press a gateway to register.

When registering a new gateway, press **[Not Programmed]**.

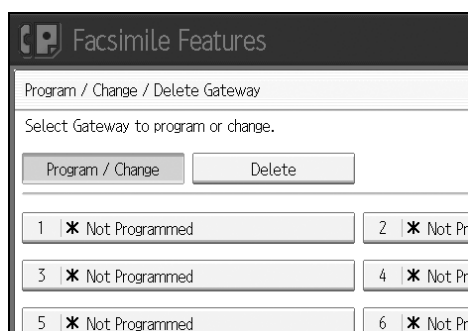

- ⑥ Press **[Change]** for “Prefix”.
- ⑦ Enter the Prefix using the number keys, and then press **[OK]**.
To change the existing prefix, press **[Clear]**, and then enter a new prefix. For documents sent using a gateway to G3 Fax, prefixes can be used. If the first several digits of IP-Fax number and the gateway- specific prefix are identical, documents can be transmitted using the registered digits of the gateway. For example, if both 03 and 04 have been registered as gateway number while 0312345678 is also specified, documents can be transmitted via a gateway for which 03 is used as a prefix.
When you wish to use the gateways regardless of the IP-Fax destination numbers, register only the gateway addresses without registering the prefix.
- ⑧ Select a protocol.

4

The screenshot shows a menu with three items: 'Prefix' with a dark grey input field, 'Select Protocol' with a dropdown menu showing 'H.323', and 'Gateway Address' with a dark grey input field.

- ⑨ Press **[Change]** for Gateway Address.
 - ⑩ Enter the gateway address, and then press **[OK]**.
 - ⑪ Press **[OK]**.
- Delete
 - ① Press **[Facsimile Features]**.
 - ② Press **[Initial Settings]**.
 - ③ Press **[Program / Change / Delete Gateway]**.
 - ④ Press **[Delete]**, and then select a gateway to delete.
 - ⑤ Press **[Yes]** on the confirmation message.
If you do not want to delete the gateway you have selected, press **[No]**.
 - ⑥ Press **[Exit]**.
 - ⑦ Press the **[User Tools/Counter]** key.

Reference

- p.133 “Memory Lock Reception”
- p.143 “Registering Fax Information”
- p.151 “Parameter Settings”
- p.161 “Memory Lock”

Reception File Setting

Specify whether received documents are to be saved on the hard disk or printed immediately without being saved. You can print stored documents repeatedly or download them as images to a computer using a Web Image Monitor or DesktopBinder. If you select printing without saving, documents are printed each time they are received.

If you have used System Settings to specify to have received faxes distributed to the delivery server, the documents cannot be saved on the hard disk.

Important

The optional printer/scanner unit is required.

1 Press [**Facsimile Features**].

2 Press [**Reception Settings**].

3 Press [**Reception File Setting**].

4 Press [**Print**] or [**Store**], and then press [**OK**].

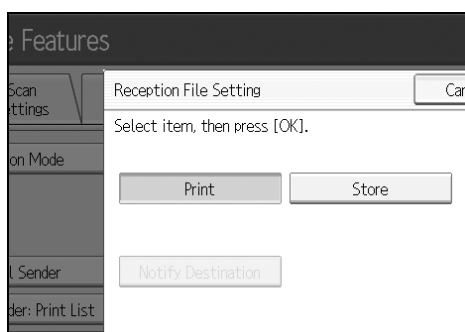

To cancel your selection, press [**Cancel**]. The display returns to that of step **3**.

When [**Store**] is selected, you can select whether or not to send notice of reception to a specific e-mail address. To notify of reception, press [**Notify Destination**] and select an e-mail address from the Internet Fax destinations programmed in the address book. Further, you can register a group destination. In such a case, a maximum of 500 destinations can be specified in a group.

5 Press the **[User Tools/Counter]** key. **Note**

- You can use "Parameter Settings" (switch 10, bit 5) to select whether or not to print stored received documents. See "Parameter Settings".
- If **[Store]** is selected and a destination for notification is specified, notification of document reception can be sent to the specified e-mail address.
- Documents saved on the hard disk are categorized as received and stored documents.
- You cannot change to a different setting if received documents have been stored on the hard disk. To change to a difference setting, print documents stored on the hard disk if necessary, and then delete them.
- Received confidential documents are stored in memory. Use the Print Confidential RX File function to print them.
- With **[Store]** selected, more memory space is used as the number of saved documents increases. After memory space becomes insufficient, no more documents are saved on the hard disk. When this happens, the machine starts printing then overwriting old documents.
- You can store received documents up to a total of approximately 320 pages or 2,240 pages of A4 size Standard <ITU-T#1Chart>.
- You cannot send received documents.
- You cannot manage stored documents from the Document Server display.
- It is recommended that you use Web Image Monitor running under the same network environment as this machine. Otherwise, the Web browser may not open and an error may occur.

 **Reference**

p.151 "Parameter Settings"

"Printing/Deleting Received and Stored Documents (Print/Delete Stored RX File)", Facsimile Reference

"Sending Stored Documents", Facsimile Reference

Reception Report e-mail

When a received document is stored, this report is sent to the e-mail address set as the destination for notification.

Program / Change / Delete Scan Size

Program frequently used scan sizes.

Important

- When programming or changing a scan size, it is recommended that you make a record of the new size.

When you select a scan size to scan a custom size original, two custom sizes are available (Program Size 1 and Program Size 2). Use these functions to program a custom size in advance. The procedure is the same for programming and changing.

You can program up to two sizes.

Specify a horizontal length from 128 to 1200 mm, or from 5.5 to 47 inches.

- 1** Press **[Facsimile Features]**.
- 2** Press **[Scan Settings]**.
- 3** Press **[Program / Change / Delete Scan Size]**.
- 4** Select **[Program Size 1]** or **[Program Size 2]**.

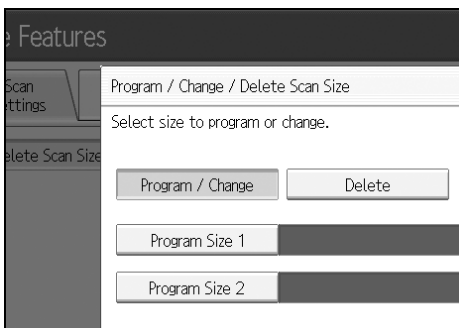

- 5** Enter a horizontal size using the number keys.

Each time you press **[mm]** or **[inch]**, the units switch between "mm" and "inch". If you enter a length and press **[mm]** or **[inch]**, the length is converted automatically according to the unit (fractions are rounded off). For example, when you enter **[2]**, **[2]**, and **[0]** in millimeters and change to "inch", the length "8.7 inch" is shown on the display. If you press **[mm]** or **[inch]** again, "221 mm" is displayed.

If you make a mistake, press **[Clear]** or the **[Clear/Stop]** key, and then try again. To cancel a scan size, press **[Cancel]**.

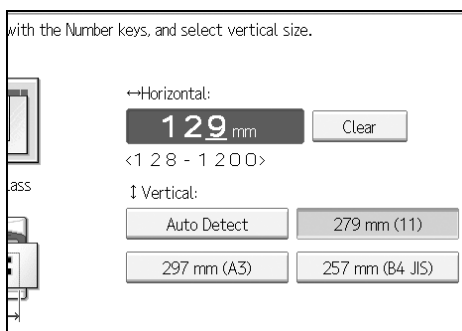
6 Select a vertical size, and then press [OK].

The displayed vertical size differs depending on the selected unit. When [mm] is selected, [Auto Detect], [210 mm (A4)], [257 mm (B4 JIS)], [297 mm (A3)], [216 mm (8 1/2)], and [279 mm (11)] are shown. When [inch] is selected, [Auto Detect], [8.3 inch (A4)], [10.1 inch (B4 JIS)], [11.7 inch (A3)], [8.5 inch], and [11.0 inch] are shown.

To cancel a scan size, press [Cancel].

7 Press [Exit].**8** Press the [User Tools/Counter] key.

Deleting a scan size

Delete programmed scan size.

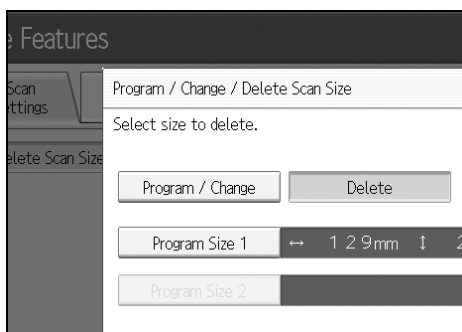
1 Press [Facsimile Features].**2** Press [Scan Settings].**3** Press [Program / Change / Delete Scan Size].**4** Press [Delete], and then select [Program Size 1] or [Program Size 2].**5** Press [Yes].

To cancel deleting, press [No]. The display returns to that of step**4**.

6 Press [Exit].**7** Press the [User Tools/Counter] key.

Registering Fax Information

You can send information to the other party when transmitting or receiving a fax document. This information is shown on the display of the other machine and printed as a report. The following information can be sent.

Important

- You can confirm programmed settings from the User Parameter List. It is recommended that you print and keep the User Parameter List when you program or change settings. See "Parameter List".

❖ Fax Header

The Fax Header is printed as the header of every fax you send. You should include your name in the Fax Header.

You can program Fax Header1 or Fax Header2. When you send originals using the destination list, you can select which Fax Header is printed on the document received by the other party.

You can register "Fax Header" using up to 32 alphanumeric characters and symbols.

You can use characters, symbols, numbers, and spaces.

You can set whether or not to print a Fax Header using **[Fax Header Print]** under Options . See "Fax Header Print", Facsimile Reference

❖ Own Name

The Own Name is sent to the other party when you send or receive a fax . This name should include your name. The Own Name is shown on the display of the other machine and printed in a report.

Own Name can be used only if the other machine is of the same manufacturer and has the Own Name function.

You can register "Own Name" using up to 20 alphanumeric characters and symbols.

❖ Own Fax Number (facsimile number of sender)

The sender's Own Fax Number is sent to the other party when sending a fax. The received facsimile number is shown on the display of the other machine and printed in a report.

This function is available regardless of the manufacturer of the other party's machine.

You can register "Own Fax Number" using up to 20 numbers, space, and "+"symbol.

Reference

"Fax Header Print", Facsimile Reference

Registering Fax Information

- 1** Press [Facsimile Features].
- 2** Press [Initial Settings].
- 3** Press [Program Fax Information].
- 4** Select the Fax Information you want to register or change.

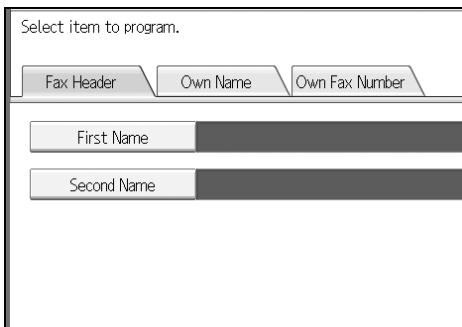

4

- 5** Register the name and facsimile number.
- 6** Press [Exit].

Registering a Fax Header

- 1** Check that [Fax Header] is selected.
- 2** Press [First Name] or [Second Name].

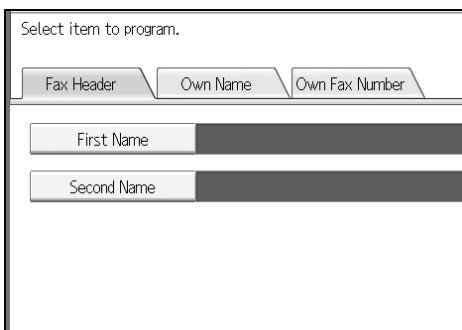

- 3** Enter a fax header, and then press [OK].

Registering an Own Name

1 Press [Own Name].

2 Press [Own Name].

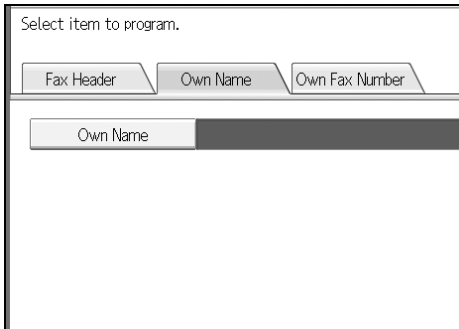

3 Enter your own facsimile's number using the number keys, and then press [OK].

Registering Fax Header

1 Press [Fax No.].

2 Select line type to program.

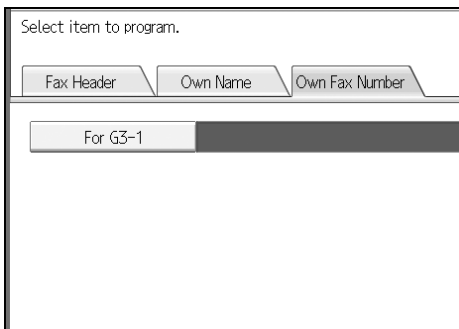

The display differs depending on the optional units installed on the machine.

3 Enter your own facsimile's number using the number keys, and then press [OK].

To enter a + sign or a space, press [+] or [Space].

Deleting Fax Information

- 1** Press **[Facsimile Features]**.
- 2** Press **[Initial Settings]**.
- 3** Press **[Program Fax Information]**.
- 4** Press **[Fax Header]**, **[Own Name]**, or **[Own Fax Number]** to delete.
- 5** Press the item you want to delete.
- 6** Press **[Backspace]** or **[Delete All]**, and then press **[OK]**.
When deleting your own facsimile's number, press **[Clear]** or the **[Clear/Stop]** key, and then press **[OK]**.
- 7** **[Exit]**.
- 8** Press the **[User tools/Counter]** key.

Forwarding

Print documents received and forward to a specified End Receiver. This is useful if, for example, you are visiting another office and would like a copy of your documents to be sent to that office.

You can also specify a "folder" as the forwarding destination.

Important

- To use this function, set Forwarding under Reception Settings to On (enable).
- You can select end receivers only from among destinations programmed in the Address Book. You cannot specify programmed transfer stations as end receivers.

A fax number, e-mail address, IP-Fax destination, and folder can be set as the forwarding destination.

Even when **[On]** is selected for "Forwarding" in "Reception Settings", if **[Off]** is selected for the forwarding destination in this function, only printing is performed, not forwarding.

When you wish to change the end receivers depending on the senders, specify the end receivers by the senders, at "Program Special Sender". Documents not received from specified senders are sent to the destination specified in this function.

Specify whether or not to print forwarded documents. See "Parameter Settings"(switch 11, bit 6).

Deleting a destination specified as a forward destination from the destination list causes the settings of the forward destination to be deleted, so they must be registered again. When a destination is changed, a document is transmitted to the new destination. If there is no destination of the specified type, you can set which destination to be used as an alternative destination. See "Parameter Settings" (switch 32, bit 0).

You can program one of the Quick Operation keys with operations for this function.

If you have specified a folder for forwarding, you can specify the file format used for forwarding. See "Parameter Settings" (switch 21, bit 3).

Reference

- p.121 "General Features"
- p.151 "Parameter Settings"
- p.128 "Reception Settings"
- p.158 "Special Senders to Treat Differently"

Programming an End Receiver

Important

- ❑ One end receiver can be registered for each special sender. To register two or more end receivers, use group destination. However, a maximum of 500 destinations can be specified in a group.

1 Press [**Facsimile Features**].

2 Press [**Reception Settings**].

3 Press [**Forwarding**].

4 Press [**On**].

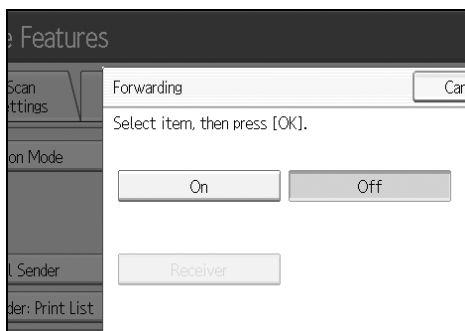

If there is an End Receiver already programmed, a receiver name is shown. If you want to change the receiver, press [**Receiver**] and proceed to step **5**.

To cancel Forwarding, press [**Off**] and proceed to step **6**.

5 Specify an End Receiver using the destination list, and then press [OK].



The receiver name is shown to the right of **[Receiver]**.

Press the key on the left of the display to switch the destination between fax number, email address, IP-Fax destination, and folder.

Set a folder destination in Address Book Management under Administrator Tools in the System Settings menu. See "Registering Folders".

If you have specified a folder for forwarding, you can specify the file format used for forwarding. See "Parameter Settings" (switch 21, bit 3).

If you make a mistake, press **[Clear]** before pressing **[OK]**, and then try again.

6 Press [OK].

7 Press the **[User Tools/Counter]** key.

Reference

p.151 "Parameter Settings"

p.238 "Registering Folders"

Quitting the forwarding function

- 1** Press [Facsimile Features].
- 2** Press [Reception Settings].
- 3** Press [Forwarding].
- 4** Press [Off], and then press [OK].

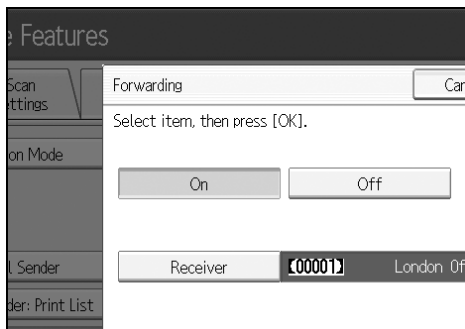

- 5** Press the [User Tools/Counter] key.

Forwarding Mark

You can print a Forwarding Mark on receiver's documents that have been forwarded.

The receiver can distinguish between forwarded and normally received documents.

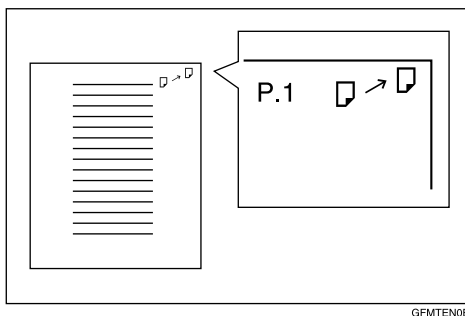

GFMTENOE

This function is not available when memory forwarding is performed to a folder destination.

Reference

p.151 "Parameter Settings"

Parameter Settings

User Parameters allow you to customize various settings to suit your needs. To change function settings, set the User Parameter Switches.

❖ Switches and Bits

Each User Parameter has a set of switches, and each of the switches consist of eight bits, whose values are "0" or "1". The right most bit is bit 0 and the left most is bit 7. You can adjust the settings to match your needs by switching the value of bits between "0" and "1".

- Switch 02

0	0	1	1	1	0	1	1
↓	↓	↓	↓	↓	↓	↓	↓
7	6	5	4	3	2	1	0

❖ User Parameter List

User Parameter Switches are outlined in the following table.

Switch	Bit	Item	0	1
02	0	Forwarding Mark	Off	On
02	3	TSI Print	Off	On
03	0	Automatic printing of the Communication Result Report	Off	On
03	2	Automatic printing of the Memory Storage Report	Off	On
03	3	Whether or not to print the SEP Code RX Reserve Report automatically.	Off	On
03	4	Whether or not to print the SEP Code RX Result Report automatically.	Off	On
03	5	Automatic printing of the Immediate TX Result Report	Off	On
03	7	Automatic printing of the Journal	Off	On
04	0	Automatic printing of the Confidential File Report	Off	On
04	1	Automatic printing of Communication Failure Report and Transfer Result Report	Off	On
04	4	Indicates the parties	Off	On
04	5	Include sender's name on reports	Off	On
04	7	Include a portion of the image on reports	Off	On
05	0	Receive Service Call (SC) Condition (Substitute Reception during service call)	Possible (Substitute RX)	Not possible (Reception off)

Switch	Bit	Item	0	1
05	2,1	Substitute the reception when the machine cannot print (because paper is jammed, all paper trays have run out of paper, toner is empty, or all paper trays are out of order)	<ul style="list-style-type: none"> • 00: Enabled unconditionally (Free) • 01: Enabled when Own Name/ Own Fax Number is received • 10: Enabled for Closed Network Code match • 11: Disabled (Reception off) 	-
05	5	Print sheet is limited to that which has highest priority.	Off	On
05	7	Empty tray alert (Paper Empty Warning) even when one paper tray is empty	Off	On
07	0	Whether or not to produce a beeping sound when the machine receives a fax.	Beep	Do not send a voice message.
07	2	Parallel Memory Transmission	Off	On
08	2	Authorized Reception Type	Receive from specified senders only.	Receive all documents except from specified senders.
10	3	Page reduction when printing	Off	On
10	5	Reception file setting	Off	On
10	6	Use both e-mail notification and printed reports to confirm the transmission results	Off	On
11	6	Local print when forwarding	Off	On
14	0	Print documents received with Auto Power-On Reception (Night Printing mode)	Immediate printing (On)	When turning on the operation switch (Off)
14	1	Long Document Transmission (Well Log)	Off	On
14	3	Reset when function changed	Off	On

Switch	Bit	Item	0	1
15	0, 1, 2	Selecting the available paper feed tray.	001: Tray 1 010: Tray 2 011: Tray 3 100: Tray 4 101: Large Capacity Tray (LCT)	-
15	5	Whether or not to select the available paper feed tray.	Off	On
17	2	Whether you need to press [Add] after specifying a destination with the Destination key when broadcasting	Not necessary	Necessary
17	3	Whether or not to reset the settings when original is scanned.	On	Off
17	7	Receive documents by pressing the [Start] key when originals are not set.	Off (no documents received after pressing the [Start] key)	On (documents received after pressing the [Start] key)
18	0	Print date with Fax Header	Off	On
18	1	Print transmitter origin with Fax Header	Off	On
18	2	Print file number with Fax Header	Off	On
18	3	Print page number with Fax Header	Off	On
19	0	Use paper delivery shift function (Offset Print)	Off	On
19	1	Sort Journal by line type	Off	On
20	0	Automatic printing of the LAN-Fax Result Report.	Off	On

Switch	Bit	Item	0	1
20	5,4,3,2	Reprinting time of stored documents in memory that could not be printed using LAN-Fax Driver	0000:0 minutes 0001:1 minutes 0010:2 minutes 0011:3 minutes 0100:4 minutes 0101:5 minutes 0110:6 minutes 0111:7 minutes 1000:8 minutes 1001:9 minutes 1010:10 minutes 1011:11 minutes 1100:12 minutes 1101:13 minutes 1110:14 minutes 1111:15 minutes	-
21	0	Print results of sending Reception Notice Request message	Off (print only when an error occurs)	On
21	1	Respond to e-mail reception acknowledgment request	Off	On
21	3	File format for files forwarded to folder destinations	TIFF	PDF
21	4	Transmit Journal by E-mail	Off	On
21	6	Display Network error	Display (On)	Not display (Off)
21	7	Transmit Error Mail Notification	On	Off
22	0	Detect a dial tone before sending faxes when using the telephone line (LINE)	Not detect (Off)	Detect (On)

Switch	Bit	Item	0	1
22	1	Detect a dial tone before sending faxes when using the telephone line (LINE2)	Not detect (Off)	Detect (On)
22	2	Detect a dial tone before sending faxes when using the telephone line (LINE3)	Not detect (Off)	Detect (On)
24	0	Store documents that could not be transmitted in memory	Off	On
24	1	Length of time documents that could not be transmitted are stored in memory	24 hours	72 hours
24	2	Whether to retain the stored file permanently	No	Yes
32	0	Select which order of priority to be used to select an alternative destination when there is no destination of the specified type.	Paper Output Priority <Priority Order> 1. IP-Fax destination 2. Fax number 3. E-mail address 4. Folder	Electronic Output Priority <Priority Order> 1. E-mail address 2. Folder 3. IP-Fax destination 4. Fax number
34	0	Use gatekeeper server with IP-Fax	Off	On
34	1	Use SIP server with IP-Fax	Off	On
35	7, 6, 5, 4, 3, 2, 1, 0	Redial interval when sending a backup file	00000000: 0 minut(s) 00000001: 1 minut(s) 00000010: 2 minut(s) . . 00001111: 15 minut(s) . . 11111111: 25 5 minut(s)	

Switch	Bit	Item	0	1
36	7, 6, 5, 4, 3, 2, 1, 0	Maximum number of redials when sending a backup file	00000000: 1 time(s) 00000001: 2 time(s) 00000010: 3 time(s) . . 11000000: 195 time(s) . . 11111111: 254 time(s)	
37	0	Whether to stop sending a backup file if the destination folder becomes full while the machine is sending or waiting to send a fax or the backup file	No	Yes
37	3, 2	Whether to print the backup file if it cannot be sent	<ul style="list-style-type: none"> • 00: Do not print • 01: Print first page only • 10: Print whole file 	

Changing the User Parameters

This section describes how to set parameters.

Important

- Access to some User Parameter Settings may require options, or other settings may need to be made beforehand.
- It is recommended that you print and keep a User Parameter list when you program or change a User Parameter.
- Do not change any bit switches other than those shown on the previous pages.

1 Press [**Facsimile Features**].

2 Press [**Initial Settings**].

3 Press [**Parameter Setting**].

4 Select the switch number you want to change.

5 Select the bit number you want to change.

When the bit number is pressed, the current value switches between 1 and 0.

Repeat from step **5** to change another bit number for the same switch.

6 Press [**OK**].

To cancel these settings, press [**Cancel**]. The display returns to that of step **4**.

7 Repeat step **4** through step **5** to change the switch settings.

8 After all the settings are finished, press [**Exit**].

9 Press the [**User Tools/Counter**] key.

Special Senders to Treat Differently

By programming particular senders in advance, you can set the following function for each sender:

- Authorized RX
- Forwarding
- Reception File Print Qty
- Print 2 Sided
- Memory Lock
- Paper Tray

4

Use Own Name or Own Fax Number to program your senders. If the sender has a machine of the same manufacturer, program an Own Name that has already been programmed as a sender. If the machine is not from the same manufacturer, Own Fax Number is used.

You can apply the same settings to all programmed numbers. You can then customize the settings for individual numbers as necessary using the Special Sender Registration function.

The following items can be programmed.

- Special Senders (Up to 30. A maximum of 20 characters for each name when using G3.)
- Full/Partial agreement
When you program own names and facsimile names for multiple destinations, you can program a common sequence of characters to identify destinations.

Destination to be programmed (Own Name)	Number of programmed identifications
NEW YORK BRANCH HONG KONG BRANCH SYDNEY BRANCH	3

Using Partial matching

Destination to be programmed (Own Name)	Number of programmed identifications
BRANCH	1

You can program up to 30 wild cards.

Spaces are ignored when identifications are compared.

You can use wild cards for the following functions:

- Forwarding
- Special Senders
- Authorized RX (Authorized Reception)

When using Partial agreement, you can enter up to the first 24 characters of an e-mail address to use it as an own name or facsimile name.

 **Note**

- You cannot program senders as Special Senders if they do not have Own Name or Own Fax Number programmed.
- The machine cannot differentiate between Polling Reception and Free Polling documents from Special Senders.
- You cannot use the following functions with Internet Fax receptions.
 - Authorized RX
 - Reception File Print Qty
 - Memory Lock
- You can program up to 24 characters for the sender.
- To use Forwarding, Print 2 Sided, or Paper Tray with Internet Fax reception, program the sender's email address.
- You can check Own Name and Own Fax Number using the Journal. You can check programmed Special Senders using the specified sender list.
- If you select "Off" for the Special Sender function in "Initial Set Up", the settings will be the same as the Reception Settings.

Authorized Reception

Use this function to limit incoming senders. The machine only receives faxes from programmed Special Senders, and therefore, it helps you screen out unwanted documents, such as junk mail, and saves wasting fax paper.

 **Note**

- To use this function, program the Special Senders function, and then select "On" in "Authorized RX" with "Reception Settings". See "Parameter Settings" (switch 08, bit 2).
- Without programming Special Senders, the Authorized RX function will not work, even if you select "On".
- If you select "Off" for "Authorized RX" in "Initial Set Up", settings are the same as the Reception Settings.
- You can change Special Senders in the same way as you program them.

 **Reference**

p.151 "Parameter Settings"
Facsimile Reference"Reception Settings"

Reception File Print Quantity

Print the specified number of copies of documents received from programmed senders (Special Senders). If you do not program any Special Senders, the machine prints the specified number of copies for all received documents

Note

- You cannot use multi-copy printing with Memory Lock.
- Specify up to 10 copies.

Forwarding

4

Print received documents, and then transfer them to those receivers programmed beforehand.

Folder destination can be registered.

It is also possible to forward faxes sent only by senders programmed as Special Senders.

Note

- To use this function, program your Special Senders, and then select "On" for "Forwarding" in "Reception Settings".
- If you specify "On" in "Forwarding" and select [**Same as Basic Settings**], the fax document is forwarded to the receivers programmed in "Specify End Receiver".
- If you do not program any Special Senders, the machine transfers all incoming documents to the other end receivers specified in "Specify End Receiver".
- You can set the fax destination, Internet fax destination, IP-Fax destination or folder destination, as a forward destination.
- Set folder destinations using the Address Book Management function under System Settings. See "Registering Folders".

Reference

p.147 "Forwarding"

p.151 "Parameter Settings"

"Reception Settings", Facsimile Reference

Print 2 Sided

Print on both sides of the paper.

Note

- If you select the bypass tray for "Paper Tray", duplex printing is disabled.

Memory Lock

Store incoming documents from programmed senders (Special Senders) in memory without printing them. People without the Memory Lock ID cannot print the documents, and therefore this function is useful for receiving confidential documents. If you do not program any senders, the machine receives fax document from all senders using Memory Lock reception.

Important

- You must register Memory Lock ID in advance.
- If you program the same sender in Memory Lock and Forwarding, Forwarding is disabled.

Reference

p.135 "Program Memory Lock ID"

Paper Tray

Print documents received from programmed senders (Special Senders) and the documents from other senders on different types of paper.

For example, if blue paper is in Tray 1 and white paper is in Tray 2, the machine prints the documents from Special Senders on the blue paper and prints the documents from other senders on the white paper, making it easy for you to separate the two.

If you do not program any Special Senders, the machine outputs documents received from all senders using the default paper tray.

Note

- If the machine receives a document that has a different size from the paper in the specified tray, the machine prints it after splitting it or minimizing its size.
- Selection of the bypass tray enables you to specify the paper size in "Scan Area".

Reference

"Placing Originals", Facsimile Reference

Programming/Changing Special Senders

Program and change Special Senders.

- 1** Press [Facsimile Features].
- 2** Press [Reception Settings].
- 3** Press [Program Special Sender].
- 4** Check [Program / Change] is selected.
- 5** Select the destination to program or change.

4

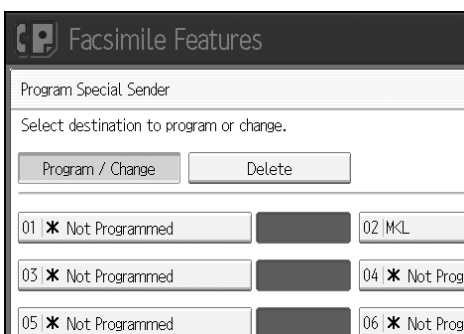

- 6** Enter a destination name, and then press [OK].
Enter a destination name using Own Name or Own Fax Number.
- 7** Press [Full Agreement] or [Partial Agreement].

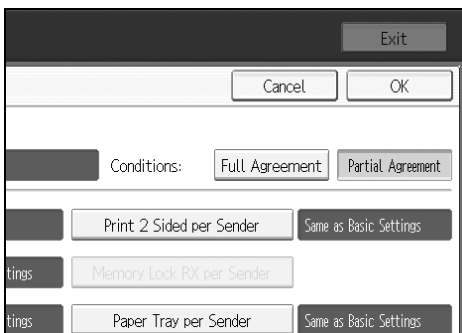

8 Select the item you want to program.

Check contents, then press [OK].

Own Name and Fax Number 0 1 LONDON OFFICE Co

Authorized Reception per Sender Off Print

RX File Print Qty per Sender Same as Basic Settings Menu

Forwarding per Sender Same as Basic Settings Pa

You must select only the item you want to program.

To cancel these settings, press **[Cancel]**. The display returns to that of step **5**.

9 Press **[OK]**.

A Special Sender is programmed.

To program another sender, repeat the procedure from step **5**.

10 Press **[Exit]**.**11** Press the **[User Tools/Counter]** key.

 **Reference**

p.158 "Full/Partial agreement"

p.164 "Authorized RX (Authorized Reception)"

p.165 "Forwarding"

p.164 "Reception File Print Qty"

p.166 "Print 2 Sided"

p.166 "Memory Lock"

p.166 "Paper Tray"

Authorized RX (Authorized Reception)

Specify when programming a Special Sender.

- 1 Press **[Authorized Reception per Sender]**.
- 2 Press **[On]** or **[Off]**, and then press **[OK]**.

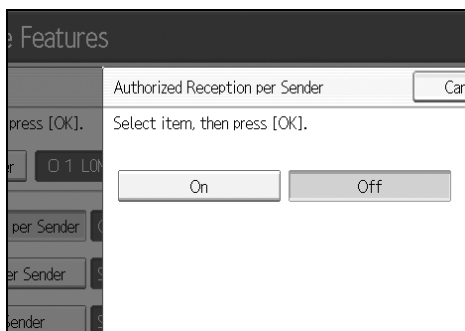

4

Reception File Print Qty

Specify when programming a Special Sender.

- 1 Press **[Reception File Print Quantity per Sender]**.
- 2 Press **[Number of Sets]**.

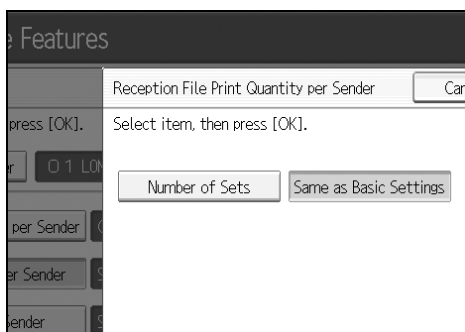

- 3 Enter the print quantity using the number keys, and then press **[OK]**.

Note

- Selecting **[Same as Basic Settings]** will result in the same setting made for "RX File Print Qty" of "Reception Settings".
- If you make a mistake, press **[Clear]** or the **[Clear/Stop]** key before pressing **[OK]**, and then try again.

Forwarding

Specify when programming a Special Sender.

Important

- ❑ One forward destination can be registered for each Special Sender. To register two or more forward destinations, use group destinations. However a maximum of 500 destinations can be specified in a group.

1 Press **[Forwarding per Sender]**.

2 Select **[On]** or **[Off]**.

If you select **[Off]**, proceed to step **4**.

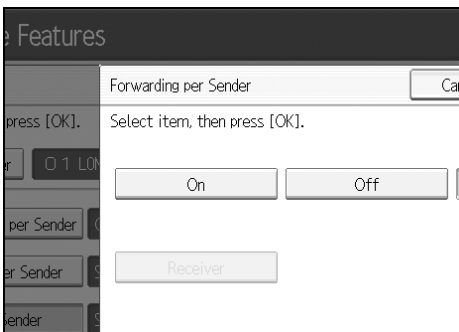

3 Press the **Destination** key of a forward destination, and then press **[OK]**.

4 Press **[OK]**.

Note

- ❑ Selecting **[Same as Basic Settings]** will result in the same setting made for "Forwarding" under "Administrator Tools".
- ❑ Press the key on the left of the display to switch the destination between fax number, e-mail address, IP-Fax destination, and folder.
- ❑ When a folder is specified as the forward destination, you can set a file format for forwarding. See "Parameter Settings" (switch 21, bit 3).
- ❑ Deleting a destination specified as a forward destination from the destination list causes the settings of the forward destination to be deleted, so they must be registered again. When a destination is changed, a document is transmitted to the new destination. If there is no destination of the specified type, you can set which destination to be used as an alternative destination. See "Parameter Settings" (switch 32, bit 0).
- ❑ After you perform step **1**, set "Forwarding" of "Reception Settings" to "On".

Reference

- p.151 "Parameter Settings"
- p.238 "Registering Folders"

Print 2 Sided

Specify when programming a Special Sender.

1 Press [2 Sided Print per Sender].

2 Press [On] or [Off], and then press [OK].

 **Note**

- Selecting [Same as Basic Settings] will result in the same setting made for "2 Sided Print" of "Reception Settings".

Memory Lock

Specify when programming a Special Sender.

1 Press [Memory Lock Reception per Sender].

2 Press [On] or [Off], and then press [OK].

 **Note**

- Selecting [Same as Basic Settings] will result in the same setting made for "Program Memory Lock ID" under "Administrator Tools".

Paper Tray

Specify when programming a Special Sender.

1 Press [Paper Tray per Sender].

2 Select the tray you want to use, and then press [OK].

 **Note**

- Selecting [Same as Basic Settings] will result in the same setting made for "Paper Tray" of "Reception Settings".

Programming Initial Set Up of a Special Sender

Program the "Initial Set Up" of a Special Sender. You can also specify the Bypass Tray Paper Size.

1 Press [Facsimile Features].

2 Press [Reception Settings].

3 Press [Program Special Sender].

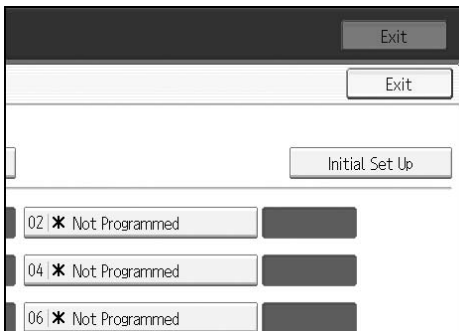
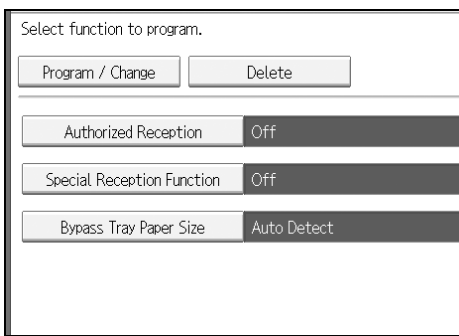
4 Press [Initial Set Up].**5** Select the function you want to program.

In this feature, “Authorized RX” has the same settings as “Reception Settings”.

6 To programming Authorized RX and Special RX Function, press [Authorized Reception] or [Special Reception Function].**7** Press [On] or [Off], and then press [OK].

The illustration shows the “Authorized RX” display as an example.

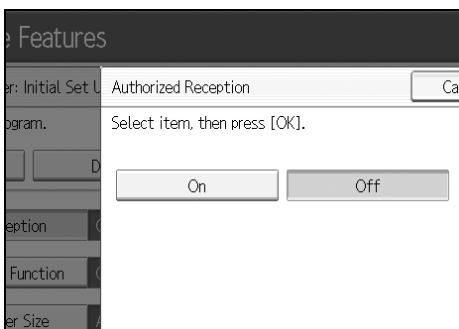
**8** To programming Bypass Tray Paper Size, press [Bypass Tray Paper Size].

You can select a size from [Auto Detect], [Standard Size], or [Custom Size].

If you select [Auto Detect], proceed to steps **9** and **14**.

If you select [Standard Size], proceed to steps **9**, **10** and **14**.

If you select [Custom Size], proceed to steps **9** and **11** to **14**.

9 Select the size you want to program.

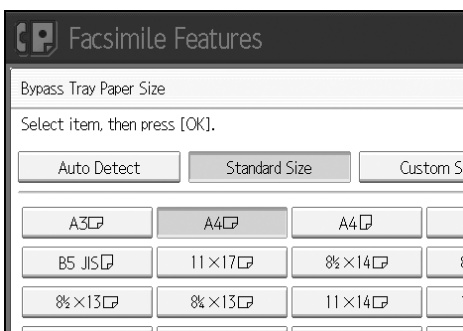

If you select **[Standard Size]**, select a paper size displayed, and then proceed to step 10.

If you select **[Custom Size]**, proceed to step 11.

10 Select the size you want to program from the sizes shown.

11 Make sure that **[Vertical]** is selected.

12 Enter the vertical size of the paper using the number keys, and then press the **[#]** key.

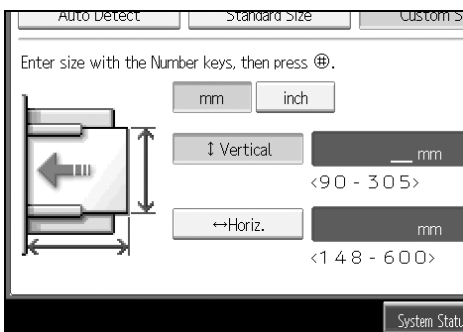

Specify a vertical size from 210 mm (8.3") to 297 mm (11.6"). You cannot enter a size smaller than 210 mm or larger than 297 mm.

Each time you press **[mm]** or **[inch]**, the units switch between "mm" and "inch". If you enter a length and change the units by pressing **[mm]** or **[inch]**, it is converted automatically (fractions are rounded off).

4

- 13** Enter the horizontal size of the paper using the number keys, and then press the [#] key.

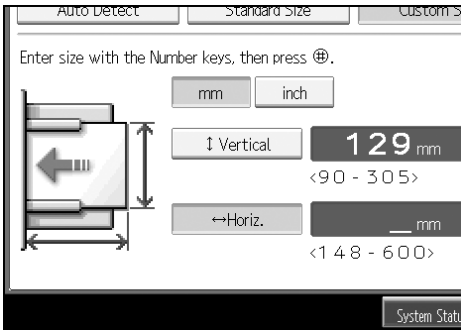

Specify a horizontal size from 148 mm (5.9") to 600 mm (23.7"). You cannot enter a size smaller than 148 mm or larger than 600 mm.

Each time you press [mm] or [inch], the units switch between "mm" and "inch". If you enter a length and change the units by pressing [mm] or [inch], it is converted automatically (fractions are rounded off).

- 14** Press [OK].
- 15** Press [Exit].
- 16** Press the [User Tools/Counter] key.

 **Note**

- If you select [Auto Detect], the machine recognizes the paper size automatically.

 **Reference**

"Reception Settings", Facsimile Reference

Deleting a Special Sender

Use this function to delete "Initial Set Up" of a Special Sender. The Bypass Tray Paper Size can also be deleted.

- 1** Press [Facsimile Features].
- 2** Press [Reception Settings].
- 3** Press [Program Special Sender].
- 4** Press [Delete], and then select the Special Sender you want to delete.
- 5** Press [Yes].

To cancel deleting a special sender, press [No]. The display returns to that of step 4.

- 6** Press [Exit].
- 7** Press the [User Tools/Counter] key.

Box Settings

The following functions are for delivery and transfer of documents:

- Personal Box
- Information Box
- Transfer Box

❖ SUB Code and SEP Code

SUB Code and SEP Code are IDs consisting of up to 20 digits, and can include numbers, #, *, and spaces.

To use this function, you must program a box and SUB/SEP Code beforehand. The other party can send documents to, and retrieve stored documents from, this box using the code.

Note

- The combined total of items that can be stored using the Personal Box, Information Box, and Transfer Box functions is 150.
- You cannot set the same Box code on two different boxes.
- Transmission or programming may not be allowed if there is not enough free memory left. The amount of free memory left differs depending on the optional equipment installed.

Programming/Changing Personal Boxes

This section describes how to program Personal Boxes.

You can program the following items:

- Box name (required)
Up to 20 characters long
- SUB Code (required)
Up to 20 characters long and can be composed of digits 0-9, "#", "*", and spaces (the first character cannot be a space).
- Password (optional)
Up to 20 characters long and can be composed of digits 0-9, "#", "*", and spaces (the first character cannot be a space).
When programming a password, a mark is displayed before the Box name.
- Receiver (optional)
You can program one delivery destination for each Personal Box. Specify a delivery destination programmed in Destination key.

1 Press [Facsimile Features].

2 Press [General Features].

3 Press [Box Setting].

4 Check that [Program / Change] is selected.

5 Select a box to program.

When programming a new box, press **[*Not Programmed]**.

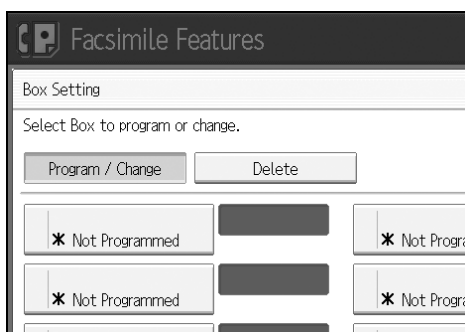

To change a box already programmed, press it and proceed to step **6**.

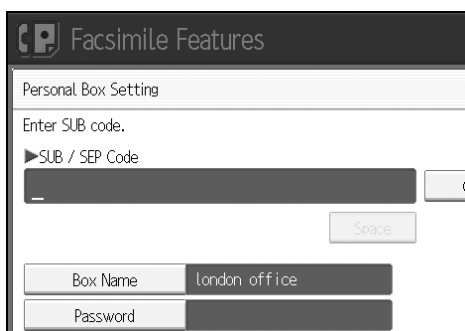
6 Press **[Personal Box]**.**7** Enter a box name, and then press **[OK]**.**8** Enter a SUB Code.

To change the SUB Code, press **[Clear]** or the **[Clear/Stop]** key, and then try again. To change a Box name, press **[Box Name]**, and then repeat from step **7**.

9 Specify the settings you require.

If you do not want to program a password or receiver, proceed to step **10**.

10 Press **[Password]**.

- 11 Enter a password, and then press [OK].

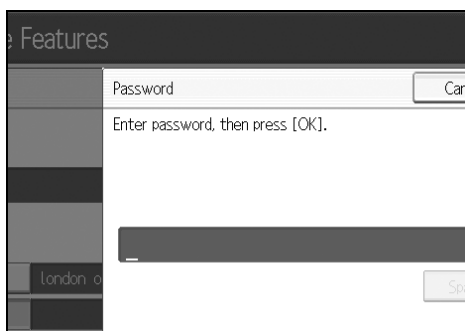

If you make a mistake, press [Clear] or the [Clear/Stop] key before pressing [OK], and then try again.

4

- 12 Re-enter the password, and then press [OK].

If you make a mistake, press [Clear] or the [Clear/Stop] key before pressing [OK], and then try again.

To change the password after pressing [OK], press [Change] and repeat steps 11 and 12, or press [Cancel] and repeat from step 10.

- 13 Press [OK].

- 14 Press [Receiver].

- 15 Select a destination using the destination list, and then press [OK].



Press the key on the left of the display to switch the destination between fax number, email address, IP-Fax destination, and folder.

- 16 Press [OK].

- 17 Press [Exit].

18 Press the **[User Tools/Counter]** key.**Note**

- When programming a password, a mark is displayed before the Box name.
- Specify a fax number, Internet Fax destination and IP-Fax destination as the transmission destination.
- The Fax Header is not printed on delivered documents.
- If a document cannot be delivered, a Communication Failure Report is printed and the document is saved as a Confidential Reception document.
- You can edit boxes in the same way you program them. However, boxes that are being used cannot be edited.
- If a destination in the destination table is deleted after being registered, delivery is not performed and the settings of the delivery destination are also deleted. Also, when a delivery destination is changed, a document is sent to the changed destination. If there is no destination of the specified type, you can set which destination to be used as an alternative destination. See "Parameter Settings" (switch 32, bit 0).

Reference

p.151 "Parameter Settings"

"Personal Boxes", Facsimile Reference

"Entering Text", About This Machine

Deleting Personal Boxes

This section describes how to delete Personal Boxes.

Important

- If there are documents in the box, you cannot delete the box.

1 Press **[Facsimile Features]**.**2** Press **[General Features]**.**3** Press **[Box Setting]**.**4** Press **[Delete]**, and then select the box you want to delete.

Select Box to delete.		
Program / Change	Delete	
☎ 12345 London office	Confidentl.	* Not Prog.
* Not Programmed		* Not Prog.
* Not Programmed		* Not Prog.
* Not Programmed		* Not Prog.

- 5** If the password is programmed, enter a password using the number keys, and then press [OK].

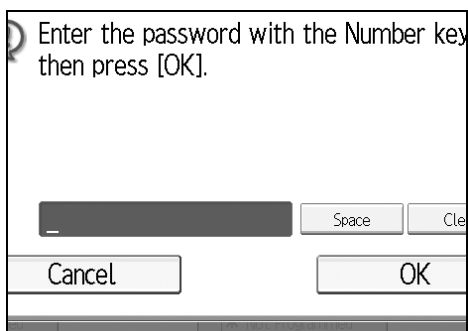

If you make a mistake, press [Clear] or the [Clear/Stop] key, and then try again.

- 6** Press [Yes].

To cancel deleting a box, press [No]. The display returns to that of step 4.

- 7** Press [Exit].

- 8** Press the [User Tools/Counter] key.

Programming/Changing Information Boxes

This section describes how to set up an Information Box.

You can store the following items:

- Box name (required)
Up to 20 characters long
- SEP Code (required)
Up to 20 characters long and can be composed of digits 0-9, "#", "*", and spaces (the first character cannot be a space).
- Password (optional)
Up to 20 characters long and can be composed of digits 0-9, "#", "*", and spaces (the first character cannot be a space).
When programming a password, a mark is displayed before the Box name.

- 1** Press [Facsimile Features].
- 2** Press [General Features].
- 3** Press [Box Setting].
- 4** Check that [Program / Change] is selected.

5 Select the box to program.

When programming a new box, press **[*Not Programmed]**.

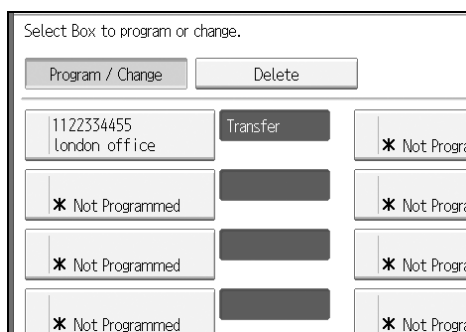

To change a box already programmed, press it, and then proceed to step 3. If a password is programmed, enter the password, press **[OK]**, and then proceed to step 3.

6 Press **[Information Box]**.

7 Enter a box name, and then press **[OK]**.

8 Enter the SEP Code.

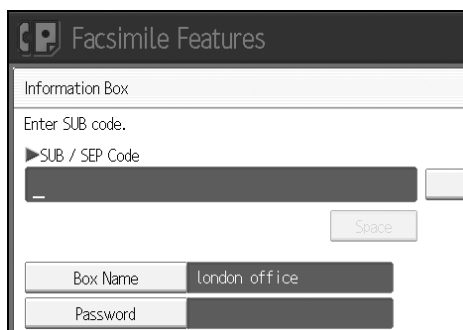

To change the SEP Code, press **[Clear]** or the **[Clear/Stop]** key, and then try again. To change the box name, press **[Box Name]**, and then repeat the procedure from step 7.

9 Press **[Password]**.

If you do not want to program a password, proceed to step 10.

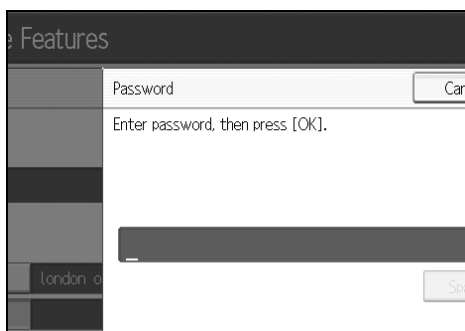
10 Enter a password, and then press [OK].

If you make a mistake, press [Clear] or the [Clear/Stop] key before pressing [OK], and then try again.

4

11 Re-enter the password, and then press [OK].

If you make a mistake, press [Clear] or the [Clear/Stop] key before pressing [OK], and then try again.

12 Press [OK].**13** Press [Exit].**14** Press the [User Tools/Counter] key.**Note**

- You can edit boxes in the same way you program them. However, boxes that are being used cannot be edited.
- If a destination in the destination list is deleted after being registered, delivery is not performed and the settings of the delivery destination are also deleted. Also, when a delivery destination is changed, a document is sent to the changed destination. If there is no destination of the specified type, you can set which destination to be used as an alternative destination. See "Parameter Settings" (switch 32, bit 0).

Reference

p.151 "Parameter Settings"

"Information Boxes", Facsimile Reference

"Entering Text", About This Machine

Deleting Information Boxes

This section describes how to delete Information Boxes.

Important

If there are documents in the box, you cannot delete the box.

1 Press **[Facsimile Features]**.

2 Press **[General Features]**.

3 Press **[Box Setting]**.

4 Press **[Delete]**, and then select the box you want to delete.

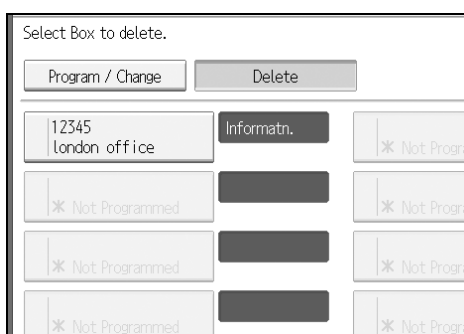

5 If the password is programmed, enter a password using the number keys, and then press **[OK]**.

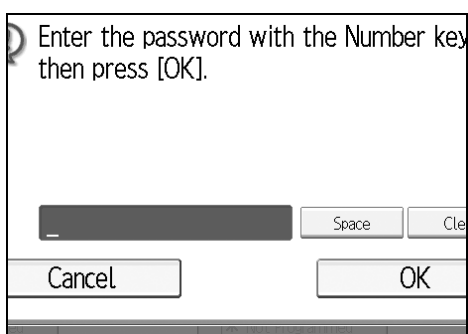

If you make a mistake, press **[Clear]** or the **[Clear/Stop]** key, and then try again.

6 Press **[Yes]**.

To cancel deleting a box, press **[No]**. The display returns to that of step **4**.

7 Press **[Exit]**.

8 Press the **[User Tools/Counter]** key.

Programming/Changing Transfer Boxes

This section describes how to set up an Transfer Box.

This function turns the machine into a fax relay station. Documents sent with a SUB Code that matches the SUB Code programmed as a Transfer Box are received, and then relayed to a programmed receiver.

Since documents can be sent to multiple destinations in a single transfer request, you can economize on call charges when sending to distant destinations.

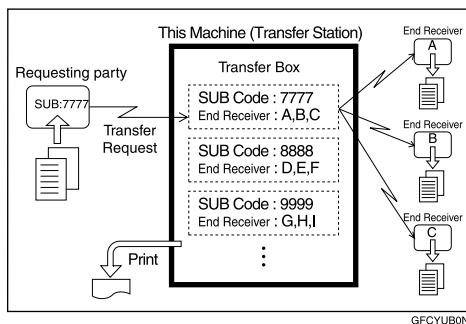

- Inform the Requesting Party of the SUB Code assigned to the Transfer Box. When they want to have a document transferred by your machine, ask them to send the document using SUB Code Transmission and specifying this SUB Code. If a password has also been programmed, inform them of this too, and ask them to enter it as the SID code.

You can store the following items:

- Box name (required)
Up to 20 characters
- SUB Code (required)
Up to 20 characters long and can be composed of digits 0-9, "#", "*", and spaces (the first character cannot be a space).
- End Receiver (required)
You can store five End Receivers (destinations to which documents are forwarded) for each box. Specify End Receivers using a single or group destination programmed in the destination list beforehand.
- Password (optional)
Up to 20 characters long and can be composed of digits 0-9, "#", "*", and spaces (the first character cannot be a space).
When programming a password, a mark is displayed in front of the Box name.

- 1** Press [Facsimile Features].
- 2** Press [General Features].
- 3** Press [Box Setting].
- 4** Check that [Program / Change] is selected.

5 Select the box to program.

When programming a new box, press **[*Not Programmed]**.

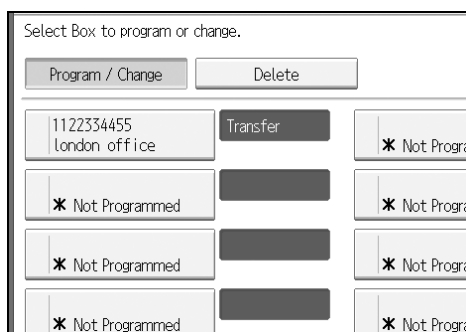

To change a box already programmed, press it, and then proceed to step 6.

6 Press **[Transfer Box]**.

7 Enter a Box name, and then press **[OK]**.

8 Enter a SUB Code.

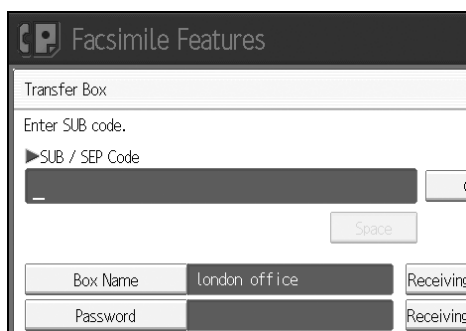

To change the SUB Code, press **[Clear]** or the **[Clear/Stop]** key, and then try again. To change Box name, press **[Box Name]**, and then repeat from step 7.

9 Specify the condition of registration.

10 To Program End Receivers, Select an End Receiver.

You can store five End Receivers.

11 Specify End Receivers with Destination keys, and then press [OK].



You can change the display to the fax destination, Internet fax destination, and IP-Fax destination using the key on the left side of the display.

4

A reception station can also be registered as a group destination. In such a case, a maximum of 500 parties including End Receivers 1-5 can be specified in a group.

To register another End Receiver, repeat from step 10.

12 To program a password, press [Password].

If you do not want to program a password, proceed to step 15.

13 Enter a password, and then press [OK].

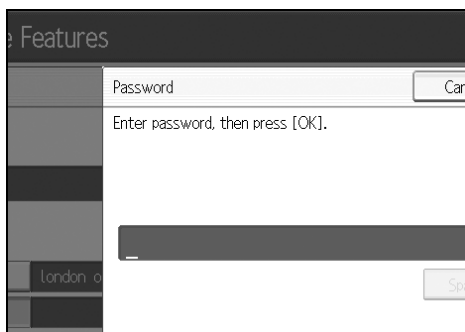

If you make a mistake, press [Clear] or the [Clear/Stop] key before pressing [OK], and then try again.

14 Re-enter the password, and then press [OK].

If you make a mistake, press [Clear] or the [Clear/Stop] key before pressing [OK], and then try again.

To change the password after pressing [OK], press [Change] and repeat steps 13 and 14, or press [Cancel] and repeat from step 12.

15 Press [OK] twice.

16 Press [Exit].

17 Press the [User Tools/Counter] key.

Note

- After documents are transferred, Transfer Result Reports are not sent back to the sender.
- Specify the Internet fax destination and IP-Fax destination as a reception station.
- After documents are transferred, they are deleted.
- When this function is set to on, the machine prints out the received documents it transfers and a Transfer Result Report after the transfer has finished. If you do not want it to print, contact your service representative.
- When the programmed receiver is a group destination for Multi-step Transfer, Multi-step Transfer takes place. For more information, contact your service representative.
- You can edit boxes in the same way you program them.
- If you delete a destination specified as a reception destination using the destination list, the settings of the reception destination are also deleted, so they must be registered again. When a destination is changed, a document is transmitted to the new destination. If there is no destination of the specified type, you can set which destination to be used as an alternative destination. See "Parameter Settings" (switch 32, bit 0).

Reference

p.151 "Parameter Settings"
"Entering Text", About This Machine

Deleting Transfer Boxes

This section describes how to delete Transfer Boxes.

- 1** Press [Facsimile Features].
- 2** Press [General Features].
- 3** Press [Box Setting].
- 4** Press [Delete], and then select the box you want to delete.

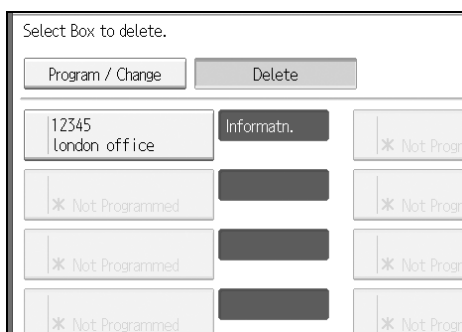

- 5** If the password is programmed, enter a password using the number keys, and then press **[OK]**.

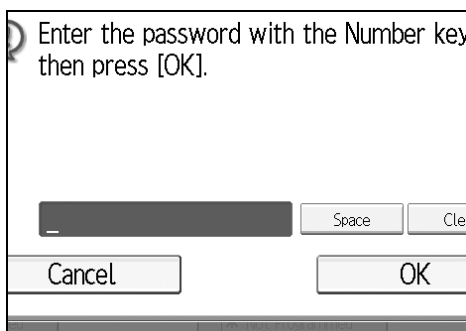

If you make a mistake, press **[Clear]** or the **[Clear/Stop]** key, and then try again.

4

- 6** Press **[Yes]**.

To cancel deleting a special sender, press **[No]**. The display returns to that of step **4**.

- 7** Press **[Exit]**.

- 8** Press the **[User Tools/Counter]** key.

Printing the Box List

Print a list showing the currently programmed Personal Boxes, Information Boxes, and Transfer Boxes.

- 1** Press **[Facsimile Features]**.
- 2** Press **[General Features]**.
- 3** Press **[Print List]** next to **[Box Setting]**.
- 4** Press the **[Start]** key.

After printing the list, you can then start from step **3**.

To cancel printing a list before pressing the **[Start]** key, press **[Cancel]** or the **[Clear/Stop]** key. The display returns to that of step **3**.

To cancel printing a list after pressing the **[Start]** key, press **[Stop Printing]**. The display returns to that of step **3**.

- 5** Press the **[User Tools/Counter]** key.

5. Printer Features

This chapter describes user tools in the Printer Features menu.

For details on how to access **[Printer Features]**, see "Accessing User Tools (System Settings)".

Reference

p.3 "Accessing User Tools (System Settings)"

Test Print

This section describes the user tools in the Test Print menu under Printer Features.

❖ Multiple Lists

You can print the configuration page and error log.

❖ Configuration Page

You can print the machine's current configuration values.

❖ Error Log

You can print error logs listing all errors that occurred during printing. The most recent 30 errors are stored in the error log. If a new error is added when there are 30 errors already stored, the oldest error is deleted. However, if the oldest error belongs to one of the following types of print jobs, it is not deleted. Instead, it will be stored separately in error logs for each job type, up to a maximum of 30 for each log. You can check any of these print jobs for error log information.

- Sample Print
- Locked Print
- Hold Print
- Stored Print

The records of Auto Job Cancel and jobs canceled manually from the control panel can be printed.

❖ Menu List

You can print a Menu List showing the machine's function menus.

❖ PCL Config./Font Page

You can print the current configuration and installed PCL font list.

❖ PS Config./Font Page

You can print the current configuration and installed PostScript font list. This menu can be selected only when the optional PostScript 3 unit is installed.

❖ **PDF Config./Font Page**

You can print the current configuration and installed PDF font list.
This menu can be selected only when the PostScript 3 unit is installed.

❖ **Hex Dump**

You can print in the Hex Dump mode.

Printing the configuration page

1 Press [Printer Features].

2 Press [Configuration Page] on the [List / Test Print].

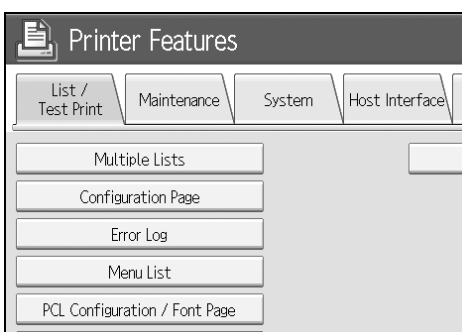

The configuration page is printed.

3 Press the [User Tools/Counter] key.

Interpreting the configuration page

❖ **System Reference**

- **Unit Number**
Displays the serial number assigned to the board by its manufacturer.
- **Total Memory**
Displays the total amount of memory (SDRAM) installed on the printer.
- **Firmware Version**
 - **Printer**
Displays the version number of the printer firmware.
 - **System**
Displays the version number of the system firmware.
 - **Engine**
Displays the version number of the printer engine.
 - **LCDC**
Displays the version number of the panel display.
 - **NIB**
Displays the version number of the Network interface.

- **Device Connection**
This item(s) appears when the device option(s) is installed.
 - **HDD: Font / Macro Download**
Displays the capacity of the hard disk drive.
 - **Printer Language**
Displays the version number of the printer driver language.
 - **Connection Equipment**
Displays the installed optional equipments.
- ❖ **Paper Input**
Displays settings made under Tray Paper Settings menu.
- ❖ **System**
Displays settings made under the System menu.
- ❖ **PCL Menu**
Displays settings made under PCL Menu.
- ❖ **PS Menu**
Displays settings made under PS Menu.
- ❖ **PDF Menu**
Displays settings made under PDF Menu.
- ❖ **Host Interface**
Displays settings made under the Host Interface menu.
When DHCP is active on the network, the actual IPv4 address, subnet mask and gateway address appear in parentheses on the configuration page.
- ❖ **Interface Information**
Displays the interface information.

Maintenance

This section describes the user tools in the Maintenance menu under Printer Features.

❖ List / Test Print Lock

You can Lock the [List / Test Print] menu.

- On
- Off

❖ Delete All Temporary Print Jobs

You can delete all print jobs temporarily stored in the machine.

❖ Delete All Stored Print Jobs

You can delete all print jobs stored in the machine.

❖ 4 Colour Graphic Mode

- Text Priority
Use the optimum CMYK toner combination for text printing.
- Photo Priority
Use the optimum CMYK toner combination for photo printing.

Reference

p.49 "System Settings"

System

This section describes the user tools in the System menu under Printer Features.

❖ **Print Error Report**

Select this to have an error report printed when a printer or memory error occurs.

- On
- **Off**

❖ **Auto Continue**

You can select this to enable Auto Continue. When it is On, printing continues after a system error occurs.

- **Off**
- Immediate
- 1 minute
- 5 minutes
- 10 minutes
- 15 minutes

❖ **Memory Overflow**

Select this to have a memory overflow error report printed.

- **Do not Print**
- Error Information

❖ **Job Separation**

You can enable Job Separation.

This menu can be selected only when a finisher (optional) is installed.

- On
- **Off**

❖ **Auto Delete Temporary Print Jobs**

You can select to automatically delete print jobs temporarily stored in the machine.

- On
- **Off**

If you select **[On]**, you can set up to 200 hours for auto file deleting.

❖ **Auto Delete Stored Print Jobs**

You can select to automatically delete print jobs stored in the machine.

- **On: 3 day(s)**
- Off

If you select **[On]**, you can set up to 180 days for auto file deleting.

❖ Initial Print Job List

You can set the desired type of print job list that appears on the screen when you press **[Print Jobs]**.

- **Complete List**
Displays the list of print jobs stored in the machine.
- **List Per User ID**
Displays the list of the User ID who stored a file in the machine.

❖ Memory Usage

You can select the amount of memory used in Font Priority or Frame Priority, according to paper size or resolution.

- **Font Priority**
This setting uses memory for registering fonts.
- **Frame Priority**
This setting uses frame memory for high speed printing.

❖ Duplex

You can select to have print on both sides of each page.

- **Off**
- **Long Edge Bind**
- **Short Edge Bind**

❖ Copies

You can specify the number of print sets. This setting is disabled if the number of pages to print has been specified with the printer driver or another command.

- 1-999
- Default: 1

❖ Blank Page Print

You can select whether or not to print blank pages.

- **On**
- **Off**

Pages that match one of the following conditions are identified as blank.

- There are no images.
- There are images but they are outside of the printable area.
- There are only blank characters.

❖ Reserved Job Waiting Time

You can specify how long the machine waits to receive a print job before allowing other functions such as the copier and scanner functions to interrupt it.

- **Long Wait**
- **Medium Wait**
- **Short Wait**
- **Off**

❖ Printer Language

Specify the printer language.

- **Auto**
- PCL
- PS
- PDF

This menu appears only when the PostScript 3 unit is installed.

❖ Sub Paper Size

You can enable the Auto Substitute Paper Size (A4, LT) feature.

- Auto
- **Off**

❖ Page Size

You can select the default paper size.

- A3
- A4
- A5
- A6
- B4JIS
- B5JIS
- B6JIS
- C5 Env
- C6 Env
- DL Env
- 12×18
- 11×17
- 8¹/₂×14
- 8¹/₂×13
- 8¹/₂×11
- 8¹/₄×13
- 8×13
- 7¹/₄×10¹/₂
- 5¹/₂×8¹/₂
- 4¹/₈×9¹/₂
- 3¹/₈×7¹/₂
- 8K
- 16K
- Custom Size

Default: Metric version: **A4**, Inch version: **8¹/₂×11**

❖ Letterhead Setting

You can rotate original images when printing.

When printing, original images are always rotated by 180 degrees. Therefore, output might not be as expected when printing onto letterhead or preprinted paper requiring orientation. Using this function, you can specify image rotation.

- **Off**

When set to Off, original images are rotated by 180 degrees.

- **Auto Detect**

When set to Auto Detect, the machine detects a letterhead or preprinted paper automatically, and does not rotate the image.

- **On (Always)**

When set to On (Always), the machine does not rotate.

This function reduces printing speed.

❖ Bypass Tray Setting Priority

Specify whether (Printer) Driver / Command or Machine Settings, has priority for determining the paper size for the bypass tray.

- **Driver / Command**

- **Machine Settings**

❖ Edge to Edge Print

You can select whether or not to print on the entire sheet.

- **Off**

- **On**

The 5 mm margin along the edges may not be printed properly.

❖ Default Printer Language

You can set the default printer language if the machine cannot find the printer language automatically.

- **PCL**

- **PS**

- **PDF**

This menu appears only when the PostScript 3 unit is installed.

❖ Tray Switching

You can set to switch the paper tray.

- **Off**

- **On**

🔍 Reference

"Loading paper", Troubleshooting

Host Interface

This section describes the user tools in the Host Interface menu under Printer Features.

❖ I/O Buffer

You can set the size of the I/O Buffer. Normally it is not necessary to change this setting.

- 128KB
- 256KB

❖ I/O Timeout

You can set how many seconds the machine should wait before ending a print job. If data from another port usually arrives in the middle of a print job, you should increase this timeout period.

- 10 seconds
- 15 second(s)
- 20 seconds
- 25 seconds
- 60 seconds

PCL Menu

This section describes the user tools in the PCL Menu under Printer Features.

❖ Orientation

You can set the page orientation.

- **Portrait**
- Landscape

❖ Form Lines

You can set the number of lines per page.

- 5 to 128 by 1
- Default: Metric version: **64**, Inch version: **60**

❖ Font Source

You can set the storage location of the default font.

- **Resident**
- RAM
- HDD
- SD

RAM, HDD and SD can be selected only when fonts have been downloaded to the machine.

❖ Font Number

You can set the ID of the default font you want to use.

- 0 to 63 by 1
- The default setting is **0**.

❖ Point Size

You can set the point size you want to use for the selected font.

- 4.00 to 999.75 by 0.25
- This setting is effective only with variable-space fonts.
The default setting is **12.00**.

❖ Font Pitch

You can set the number of characters per inch for the selected font.

- 0.44 to 99.99 by 0.01
- This setting is effective only with fixed-space fonts.
The default setting is **10.00 pitches**.

❖ Symbol Set

Specify the set of print characters for the selected font. The available options are as follows:

Roman-8, ISO L1, ISO L2, ISO L5, **PC-8**, PC-8 D/N, PC-850, PC-852, PC8-TK, Win L1, Win L2, Win L5, Desktop, PS Text, VN Intl, VN US, MS Publ, Math-8, PS Math, VN Math, Pifont, Legal, ISO 4, ISO 6, ISO 11, ISO 15, ISO 17, ISO 21, ISO 60, ISO 69, Win 3.0

❖ Courier Font

You can select a courier font type.

- **Regular**
- Dark

❖ Extend A4 Width

You can extend the printing area width (when printing on A4 sheet with PCL).

- **Off**
- On

When the setting is On, the width will be 8¹/₂ inches.

❖ Append CR to LF

When set to On, a carriage return will follow each line feed: CR=CR, LF=CR-LF, FF=CR-FF.

- **Off**
- On

❖ Resolution

You can set the print resolution in dots per inch.

- 300 dpi (B&W)
- **600 dpi (Fast)**
- 600 dpi (Standard)
- 600 dpi (High Quality)

PS Menu

This section describes the user tools in the PS Menu under Printer Features. This menu appears only when the optional PostScript 3 unit is installed.

❖ Data Format

You can select a data format.

- Binary Data
- **TBCP**

This setting is not effective when operating the machine with a parallel or EtherTalk connection.

When operating the machine with a parallel connection, and also if the binary data is sent from the printer driver, the print job is canceled.

When operating the machine with an Ethernet connection, the print job is canceled under the following conditions;

- The printer driver data format is TBCP, and the data format selected on the display panel is Binary Data.
- The printer driver data format is binary, and the data format selected on the display panel is TBCP.

❖ Resolution

You can set the print resolution in dots per inch.

- **600 dpi (Fast)**
- 600 dpi (Standard)
- 600 dpi (High Quality)

❖ Colour Setting

You can make an RGB setting.

- Off
- Fine
- **Super Fine**

❖ Colour Profile

You can set the colour profile.

- **Auto**
- Presentation
- Solid Colour
- Photographic
- User Setting

PDF Menu

This section describes the user tools in the PDF Menu under Printer Features.

❖ **Change PDF Password**

Set the password for the PDF file executing PDF Direct Print.

- Current Password
- New Password
- Confirm New Password

A password can be set using on the Web Image Monitor, but in this case the password information is sent through the network. If security is a priority, set the password using this menu from the Control Panel.

❖ **PDF Group Password**

Set the group password already specified with DeskTopBinder.

- Current Password
- New Password
- Confirm New Password

A password can be set using on the Web Image Monitor, but in this case the password information is sent through the network. If security is a priority, set the password using this menu from the Control Panel.

❖ **Resolution**

You can set the print resolution in dots per inch.

- **600 dpi (Fast)**
- 600 dpi (Standard)
- 600 dpi (High Quality)

❖ **Colour Setting**

You can make an RGB setting.

- None
- Fine
- **Super Fine**

❖ **Colour Profile**

You can set the colour profile.

- **Auto**
- Presentation
- Solid Colour
- Photographic
- User Setting

6. Scanner Features

This chapter describes user tools in the Scanner Features menu.

For details on how to access **[Scanner Features]**, see "Accessing User Tools (System Settings)".

Reference

p.3 "Accessing User Tools (System Settings)"

General Settings

This section describes the user tools in the General Settings menu under Scanner Features.

❖ **Switch Title of Quick Dial Table**

Select the title to be shown on the destination list.

❖ **Update Delivery Server Destination List**

Press **[Update Delivery Server Destination List]** to update the receivers from the delivery server. To use this function, it is necessary to set **[Delivery Option]** to **[On]**.

❖ **Search Destination**

Select a destination list to be used in "Search Destination".

To search from LDAP server, it is necessary to register the LDAP server in **[System Settings]** and set **[LDAP Search]** to **[On]**.

❖ **TWAIN Standby Time**

When the machine is being used to send e-mail or a file, or functioning as Document Server or a network delivery scanner, a scanning request to the machine as a TWAIN scanner will switch the machine to the network TWAIN scanner function. This setting determines the delay until the machine switches to the network TWAIN scanner function.

- **Off**
When **[Off]** is selected, the machine will switch to the network TWAIN scanner function at once.
- **On: 10 sec.**
When **[On]** is selected, you can enter the delay time with the number keys (3-30 seconds). The machine will switch to the network TWAIN scanner function when the time set here passes after the last key operation.

❖ **Destination List Display Priority 1**

Select a destination list to be displayed when the machine is in the initial state. You can select either **[E-mail / Folder]** or **[Delivery Server]**.

- E-mail / Folder
- **Delivery Server**

❖ Destination List Display Priority 2

In the machine's address book, select which address book appears by default. You can select either **[E-mail Address]** or **[Folder]**.

- **E-mail Address**
- Folder

❖ Print & Delete Scanner Journal

Up to 100 transmission/delivery results can be checked on this machine. If the stored transmission/delivery results reach 100, select whether to print the delivery journal.

- **Print and Delete All**

The transmission/delivery journal is printed automatically. The printed journal is deleted.

- **Do not Print: Delete Oldest**

Transmission/delivery results are deleted one by one as new results are stored.

- **Do not Print: Disable Send**

Transmission/delivery cannot be performed when the journal is full.

When printed, all records are deleted after printing. When not printed, records over the limit are automatically deleted in succession from the oldest record.

While the journal is being printed, files with the status waiting cannot be sent.

❖ Print Scanner Journal

The scanner journal is printed and deleted.

❖ Delete Scanner Journal

The scanner journal is deleted without being printed.

Scan Settings

This section describes the user tools in the Scan Settings menu under Scanner Features.

❖ A.C.S. Sensitivity Level

Sets the sensitivity level for judging colour/black and white for scanning originals when **[Scan Type]** is set to **[Auto Colour Select]**.

❖ Wait Time for Next Orig.: Exposure Glass

When dividing originals and scanning them individually with the exposure glass to form a single file, select **[Continuous Wait]**, **[Off]**, or **[Set Wait Time]** for the waiting status.

- Continuous Wait
- Off
- **Set Wait Time: 60 sec.**

If you select **[SADF]** in **[Original Feed Type]** on the Scan to Folder screen, the **[Wait Time for Next Orig.: Exposure Glass]** setting becomes invalid.

If you select **[Batch]** in **[Original Feed Type]** on the Scan to Folder screen, the **[Wait Time for Next Orig.: Exposure Glass]** setting becomes invalid, and the machine waits for an additional original to be put in place.

If **[Set Wait Time]** is selected, enter the wait time in seconds (3-999) for placing additional originals with the number keys. Scanning will start if additional originals are placed and the **[Start]** key is pressed within this time. You can end scanning and begin transmission by pressing the **[#]** key within this time. Once the specified time has elapsed, transmission starts automatically.

If **[Continuous Wait]** is selected, the machine will wait for additional originals until the **[#]** key is pressed. Scanning will start when additional originals are placed and the **[Start]** key is pressed. You can end scanning and begin sending by pressing the **[#]** key.

If originals are placed in the auto document feeder (ADF), transmission will start without waiting for additional originals after all originals in the ADF have been scanned, regardless of the specified settings.

If a paper misfeed occurs or any of the following operations is performed while the machine is waiting for additional originals, the countdown stops and does not start again until the **[#]** key is pressed.

- Changing the settings such as the scan settings
- Opening the upper cover of the ADF
- Pressing the **[Interrupt]** key to activate the copy mode

❖ **Wait Time for Next Original(s): SADF**

When dividing originals and scanning them separately with the ADF to form a single file, select **[Set Wait Time]** or **[Continuous Wait]** for the waiting status.

- Continuous Wait
- **Set Wait Time: 60 sec.**

This setting is valid if **[SADF]** is specified for **[Original Feed Type]** when scanning.

If **[Set Wait Time]** is selected, enter the wait time in seconds (3-999) for placing additional originals with the number keys. Scanning will start automatically if additional originals are placed within this time. You can end scanning and begin transmission by pressing the **[#]** key within this time. Once the specified time has elapsed, transmission starts automatically.

If **[Continuous Wait]** is selected, the machine will wait for the additional originals until the **[#]** key is pressed. Scanning will start when additional originals are placed and the **[Start]** key is pressed. You can end scanning and begin sending by pressing the **[#]** key.

Even if originals are placed on the exposure glass, the machine will operate according to the specified settings. However, every time originals are placed on the exposure glass, you must press the **[Start]** key to start scanning. Scanning will start if additional originals are placed and the **[Start]** key is pressed within this time. You can end scanning and begin transmission by pressing the **[#]** key within this time. Once the specified time has elapsed, transmission starts automatically.

If originals are placed in the auto document feeder (ADF), transmission will start without waiting for additional originals after all originals in the ADF have been scanned, regardless of the specified settings.

If a paper misfeed occurs or any of the following operations is performed while the machine is waiting for additional originals, the countdown stops and does not start again until the **[#]** key is pressed.

- Changing the settings such as the scan settings
- Opening the upper cover of the ADF
- Pressing the **[Interrupt]** key to activate the copy mode

❖ **Background Density of ADS (Full Colour)**

Characteristics due to the type of paper such as nonwhiteness like newspaper or transparent originals can be reduced by correcting the scanning density.

Reference

"Batch, SADF", Scanner Reference

"Items for Specifying Scan Settings", Scanner Reference

"Setting Items for Original Feed Type", Scanner Reference

"Scanning Multiple Pages of Originals as One File", Scanner Reference

Send Settings

This section describes the user tools in the Send Settings menu under Scanner Features.

❖ **Compression (Black & White)**

Select whether or not to compress black and white scan files.

- **On**
- **Off**

Compression reduces the time required for transferring the scan file. The actual time required for file transfer will vary depending on the file size and network load.

❖ **Compression (Gray Scale / Full Colour)**

Specify whether or not to compress multi-level (grayscale / full colour) scan files.

- **On**
- **Off**

If you select **[On]**, you can specify the compression level between one and five. The image quality is better for lower compression, but the time required for file transfer increases accordingly.

The actual time required for file transfer will vary depending on the file size and network load.

❖ **High Compression PDF Level**

Select compression level when creating high compression PDF files.

- **Higher**
- **Standard**

❖ **Max. E-mail Size**

Select whether or not to limit the size of an e-mail to which an image is attached.

- **On**
- **Off**

When **[On]** is selected, enter the size limit (128-102400 KB) with the number keys.

When the SMTP limits the size, match that setting.

❖ **Divide & Send E-mail**

This function is effective only when **[On]** is selected for **[Max. E-mail Size]**. Select whether or not an image exceeding the size specified in **[Max. E-mail Size]** should be divided and sent using more than one e-mail.

- **Yes (per Max. Size)**
- Yes (per Page)
- Off

When **[Yes (per Max. Size)]** is selected, enter the Max. Number of Divisions (2-500) with the number keys.

When **[Multi-page: TIFF]** or **[Multi-page: PDF]** is selected for **[File Type]**, the image will not be divided even if **[Yes (per Page)]** is selected.

When **[Yes (per Max. Size)]** is selected, some received files may not be able to be restored, depending on the type of e-mail software.

When **[No]** is selected, the e-mail is not sent if its size exceeds the limit, and an error message appears. The scan file is discarded.

Set the maximum e-mail size within the capacity of the SMTP server.

❖ **E-mail Information Language**

Select the language in which email information such as title, document name, and sender's name is sent.

Select one of the following 20 languages:

British English, American English, German, French, Italian, Spanish, Dutch, Portuguese, Polish, Czech, Swedish, Finnish, Hungarian, Norwegian, Danish, Japanese, Simplified Chinese, Traditional Chinese, Russian, and Hangul. The e-mail text which is a template cannot be changed.

❖ **No. of Digits for Single Page Files**

Sets digit number for serial number to attach to Single Page file name.

- **4 Digits**
- 8 Digits

❖ **Stored File E-mail Method**

Specify the e-mail setting for sending stored files. You can select **[Send File]** or **[Send URL Link]**. This setting can be used for the following:

- **Send File**
Sending Stored Files by E-mail
- **Send URL Link**
Simultaneous Storage and Sending by E-mail

If you select **[Send File]**, actual files are attached to e-mails.

If you select **[Send URL Link]**, URL Links to file locations are attached to e-mails.

7. Registering Addresses and Users for Facsimile/Scanner Functions

This chapter describes how to register destinations and users in the Address Book.

For details on how to access **[System Settings]** see "Accessing User Tools (System Settings)".

Reference

p.3 "Accessing User Tools (System Settings)"

Address Book

Registering information such as the names of users and their e-mail addresses in the Address Book allows you to manage them easily.

Important

- Address Book data is stored on the hard disk. It can be lost if there is some kind of hard disk failure. The manufacturer shall not be responsible for any damages resulting data loss.

You can register and manage the following items in the Address Book:

❖ Names

You can register the name of the user and the key display. This is the basic information required for managing user of the machine.

To register a fax number or e-mail address in the address book, you must register information such as the user name and destination name in advance.

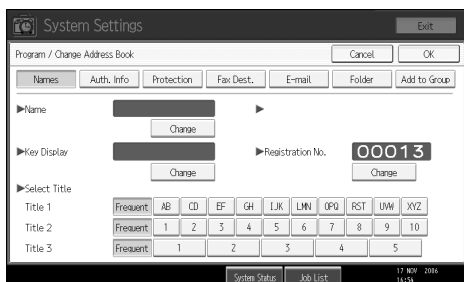

❖ **Auth. Info**

You can register user codes in order to restrict particular functions to certain users, and to check their use of each function. You can also register login user names and login passwords to be used when sending e-mail, sending to folders, or accessing an LDAP server.

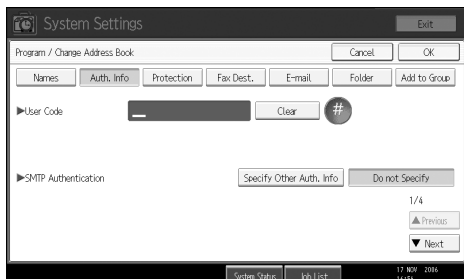

❖ **Protection**

You can set protection codes to stop sender's name from being used or folders from being accessed without authorization.

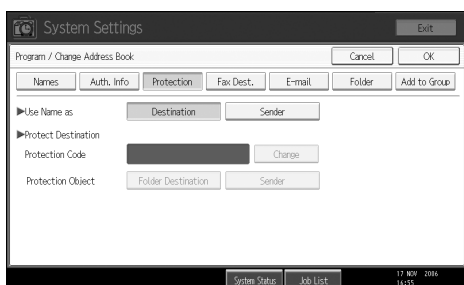

7

❖ **Fax Dest.**

You can register fax numbers, line, fax header and select label insertion. When using IP-Fax, you can register the IP-Fax destination and select the protocol.



❖ E-mail Address

You can register e-mail destinations in the Address Book.



❖ Folder

You can register the protocol, path name and server name.

- SMB

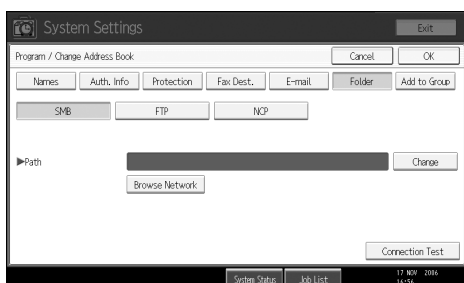

- FTP

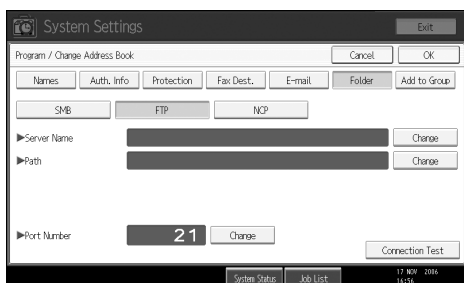

- NCP

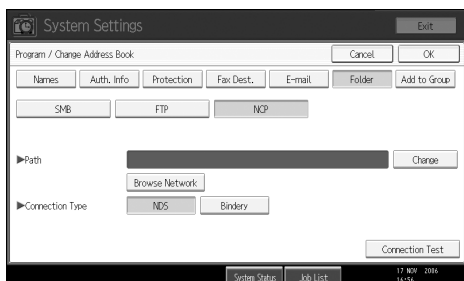

❖ **Add to Group**

You can put registered e-mail and folder destinations into a group for easier management.



Note

- ❑ You can also use a Web Image Monitor to register names in the Address Book. With the SmartDeviceMonitor for Admin, you can register multiple names at the same time.
- ❑ Using **[Address Management Tool]** in SmartDeviceMonitor for Admin, you can backup Address Book data. We recommend backing up data when using the Address Book.
- ❑ For details about using Web Image Monitor, see the Web Image Monitor Help.
- ❑ For operating instructions, see SmartDeviceMonitor for Admin Help.

7

Managing names in the Address Book

By registering a name and key display beforehand, you can specify email and folder destinations simply by selecting the name key.

Reference

p.209 "Registering Names"

Sending fax by Quick Dial

Register a fax number in the Address Book so you can specify it only by selecting the fax destination, shown on the fax initial display when sending a fax. When label insertion is set to "On", the receiver's name and standard messages are printed on the fax message when it is received at the other end.

By registering IP-Fax destinations in the Address Book, you can specify a destination simply by selecting it from the destinations that appear in the initial fax display. Registered IP-Fax numbers can be used and printed as sender's IP-Fax numbers.

Reference

p.221 "Fax Destination"

Sending e-mail by Quick Dial

By registering e-mail addresses in the Address Book, you can specify e-mail destinations simply by selecting them from the fax initial display when sending a document by internet fax.

You can also specify an e-mail address by selecting the destination shown on the initial scanner display when sending a document using the scanner function. A registered e-mail address can be used as the sender's address, and the sender's address are automatically entered in the "From" field of an email header.

Reference

p.234 "E-mail Destination"

Sending scanned files to a shared folder directly

After registering the path name, user name and password, you can connect to a shared folder simply by selecting the destination shown on the initial scanner display whenever sending files using the scanner function to a shared folder.

To share the folder using Windows, select the SMB protocol.

To register the folder to the FTP server, select the FTP protocol.

To register the folder to the NetWare server, select the NCP protocol.

Reference

p.238 "Registering Folders"

Preventing unauthorized user access to shared folders from the machine

After registering a protection code, you can specify the object of protection to prevent an e-mail destination from being used without permission.

You can prevent unauthorized access to registered folders.

Reference

p.265 "Registering a Protection Code"

Managing users and machine usage

Register user codes to limit users to the following functions and check their use of each function:

- Copier
- Document Server
- Facsimile
- Scanner
- Printer

 **Reference**

p.212 “Authentication Information”

Registering Names

Register user information including their names.

The user name is useful for selecting a destination when sending faxes or e-mail. You can also use it as a folder destination.

You can register up to 2000 names.

Registering Names

This section describes how to register names.

- 1 Press [System Settings].



- 2 Press [Administrator Tools].
- 3 Press [Address Book Management].
- 4 Check that [Program / Change] is selected.
- 5 Press [New Program].
- 6 Press [Change] on the right of the Name.
The name entry display appears.
- 7 Enter the name, and then press [OK].
- 8 Press the key for the classification you want to use under Select Title.

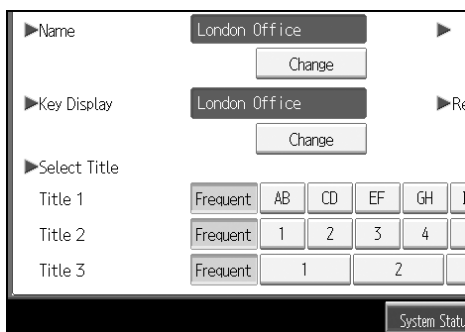

9 Press [OK] twice.

10 Press the [User Tools/Counter] key.

 **Note**

- The name can be used for documents in the Document Server. For details about the Document Server, see "Using the Document Server", Copy / Document Server Reference.
- The keys you can select are as follows:
 - [Frequent]: Added to the page that is displayed first.
 - [AB], [CD], [EF], [GH], [IJK], [LMN], [OPQ], [RST], [UVW], [XYZ], [1] to [10]: Added to the list of items in the selected title.
- You can select [Frequent] and one more page for each title.

 **Reference**

"Entering Text", About This Machine

"Using the Document Server", Copy / Document Server Reference

Changing a Registered Name

This section describes how to change a name.

7

1 Press [System Settings].

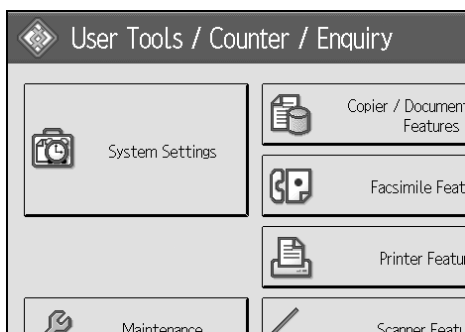

2 Press [Administrator Tools].

3 Press [Address Book Management].

4 Check that [Program / Change] is selected.

5 Select the registered name you want to change.

Press the name key, or enter the registered number using the number keys.

6 To change the name or key display, press [Change] on the right of the name or key display.

7 Enter the name or key display, and then press [OK].

- 8** To change the title, press the key for the classification you want to use from Select Title.

 **Note**

- You can search by the registered name, user code, fax number, folder name, e-mail address, or IP-Fax destination.

 **Reference**

"Entering Text", About This Machine

To change a registration number

- 1** Press [Change] to the right of "Registration No."
- 2** Enter a new registration number using the number keys, and then press the [#] key.

Deleting a Registered Name

This section describes how to delete a name.

- 1** Press [System Settings].



- 2** Press [Administrator Tools].
- 3** Press [Address Book Management].
- 4** Press [Delete].
- 5** Select the name you want to delete.
Press the name key, or enter the registered number using the number keys.
- 6** Press [Yes].
- 7** Press [Exit].
- 8** Press the [User Tools/Counter] key.

Authentication Information

Following describes the procedure for authenticating a user code.

Important

- The functions associated with each user code are the same. If you change or delete user codes, management data and limits associated with that code become invalid.

Register user codes to limit users to the following functions and check their use of each function:

Copier

Document Server

Facsimile

Scanner

Printer

Note

- You can register up to 500 user codes.
- The number of copies made of documents stored in the Document Server using the facsimile function is counted for each user code. This allows you to check each user's usage.
- The number of copies scanned using the scanner function is counted for each user code. This allows you to check each user's usage.
- To automatically register the printer driver user code, select **[Printer: PC Control]** for the printer in User Code Authentication. To use the user code set in User Tools, set the user codes registered in User Tools for the printer driver.
- For details about setting user codes for the printer driver, see Printer Driver Help.

Reference

p.82 "User Authentication Management"

Registering a User Code

This section describes how to register a user code.

- 1 Press **[System Settings]**.



- 2 Press **[Administrator Tools]**.
- 3 Press **[Address Book Management]**.
- 4 Check that **[Program / Change]** is selected.
- 5 Press the name whose code is to be registered, or enter the registered number using the number key.

You can search by the registered name, user code, fax number, folder name, e-mail address, or IP-Fax destination.

- 6 Press **[Auth. Info]**.
- 7 Enter the user code using the number keys, and then press **[#]** key.

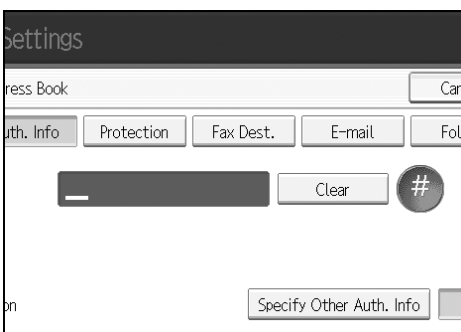

If you make a mistake, press **[Clear]** or the **[Clear/Stop]** key.

- 8 Press **[▼Next]** twice.

9 Select the functions to be used with the user code from Available Functions.



10 Press [OK].

11 Press [Exit].

12 Press the [User Tools/Counter] key.

Note

- You can enter a one-to eightdigit user code.
- To register the name, see Registering Names”.

Reference

p.209 “Registering Names”

Changing a User Code

This section describes how to change a user code.

Important

- Even if you change a user code, the counter value will not be cleared.

1 Press [System Settings].



2 Press [Administrator Tools].

3 Press [Address Book Management].

4 Check that [Program / Change] is selected.

5 Select the user whose user code you want to change.

Press the name key, or enter the registered number using the number keys.

You can search by the registered name, user code, fax number, folder name, e-mail address, or IP-Fax destination.

6 Press [Auth. Info].

7 Press [Change], and then enter the new user code using the number keys

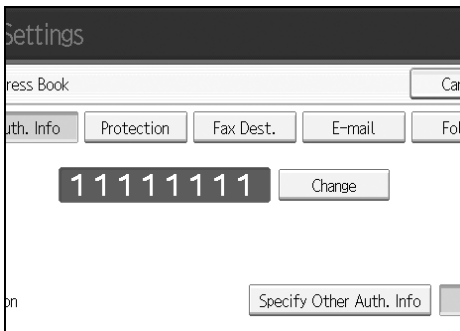

8 Press [#] key.

9 To change the available functions, press [Auth. Info] and then press [▼Next] twice.

10 Press the key to select the functions to enable them.

Press the key to highlight it, and then the function is enabled. To cancel a selection, press the highlighted key.

11 Press [OK].

12 Press [Exit].

13 Press the [User Tools/Counter] key.

 **Note**

- To change the name, key display and title, see "Changing a Registered Name".

 **Reference**

p.210 "Changing a Registered Name"

Deleting a User Code

This section describes how to delete a user code.

Important

- After clearing the user code, the counter is automatically cleared.

1 Press [System Settings].



2 Press [Administrator Tools].

3 Press [Address Book Management].

4 Press [Delete].

5 Select the name whose code is to be deleted.

Press the name key, or enter the registered number using the number keys.

You can search by the registered name, user code, fax number, folder name, e-mail address, or IP-Fax destination.

6 Press [Auth. Info].

7 Press [Change] to delete the user code, and then press [#] key.

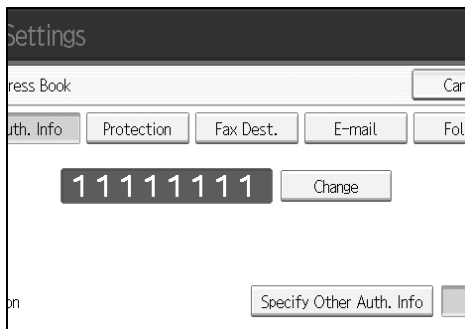

8 Press [OK].

9 Press [Exit].

10 Press the [User Tools/Counter] key.

Note

- ❑ To delete a name from the Address Book entirely, see “Deleting a Registered Name”.

Reference

p.211 “Deleting a Registered Name”

Displaying the Counter for Each User

This section describes how to display the counter for each user.

- 1** Press [System Settings].

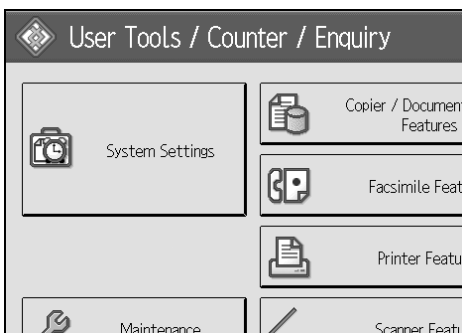

- 2** Press [Administrator Tools].

- 3** Press [Display / Clear / Print Counter per User].

- 4** Select the function usage you want to print from [Copier Counter], [Print Counter], [Fax Counter] or [Scanner Counter].

Counters for individual function usage under each user code appear.

Printing the Counter for Each User

This section describes how to print the counter for each user.

- 1** Press [System Settings].



- 2** Press [Administrator Tools].

3 Press **[Display / Clear / Print Counter per User]**.

4 Select a user code from the left side of the display.

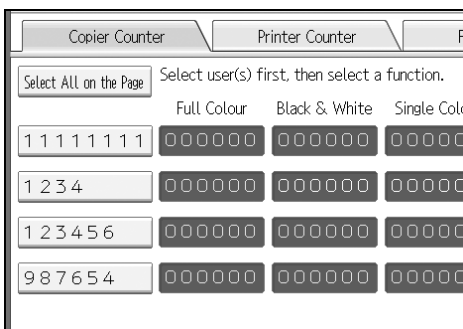

Press **[Select All on the Page]** to select all user codes on the page.

5 Press **[Print Counter List]** under Per User.

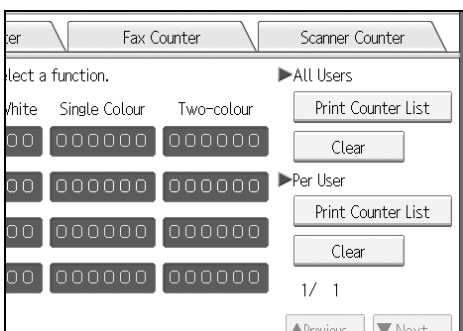

Enter the user code, and then press **[#]** if the user code is registered.

6 Select the function usage you want to print from **[Copier Counter]**, **[Print Counter]**, **[Fax Counter]**, and **[Scanner Counter]**.

7 Press **[Print]**.

Printing the Counter for All User

This section describes how to print the counter for all user.

- 1 Press **[System Settings]**.



- 2 Press **[Administrator Tools]**.
- 3 Press **[Display / Clear / Print Counter per User]**.
- 4 Press **[Print Counter List]** under All Users.

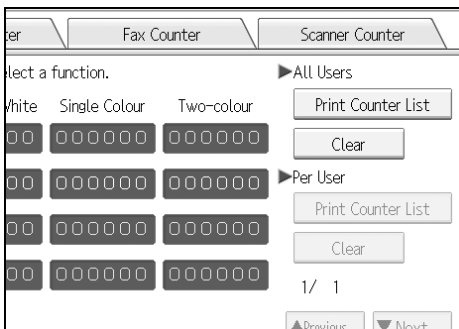

Enter the user code, and then press **[#]** if the user code is registered.

- 5 Select the function usage you want to print from **[Copier Counter]**, **[Print Counter]**, **[Fax Counter]**, and **[Scanner Counter]**.
- 6 Press **[Print]**.

Clearing the Number of Prints

This section describes how to clear the counter.

- 1 Press [System Settings].

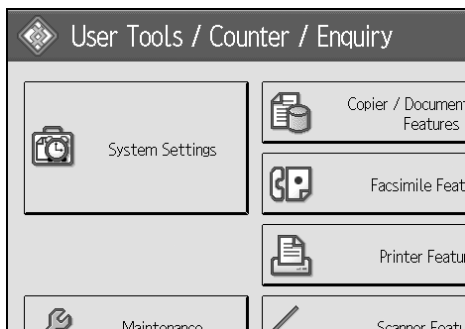

- 2 Press [Administrator Tools].

- 3 Press [Display / Clear / Print Counter per User].

- 4 Select the user code to clear.

- 5 To clear the number of prints made under a user code, Select the user code from the left side of the display.

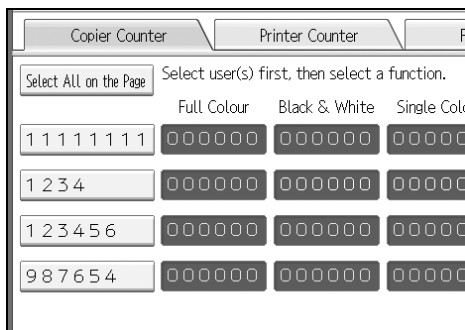

Press [Select All on the Page] to select all user codes on the page.

- 6 Press [Clear] under Per User Codes.

- 7 Select the function usage you want to clear from [Copier Counter], [Print Counter], [Fax Counter], and [Scanner Counter].

- 8 Press [OK].

- 9 To clear the number of prints for all user codes, press [Clear] under All Users.

- 10 Select the function usage you want to clear from [Copier Counter], [Print Counter], [Fax Counter], and [Scanner Counter].

- 11 Press [OK].

Fax Destination

Register a fax destination so you do not need to enter fax numbers each time, and can send documents that have been scanned in using the facsimile function.

- It is easy to select the fax destination if you register "Name" and "Key Display" for the fax destination.
- You can register fax destinations as a group. For details about registering a group, see "Registering Names to a Group".
- You can register fax destinations by selecting them from redial function.
- Registered Fax numbers can be used as sender's Fax numbers.

There are two types of fax destination, as shown below:

- **Fax Destination**
Select this to send the fax over the telephone network.
- **IP-Fax**
Select this to send the fax to a machine on a TCP/IP network.
You cannot send the fax to a machine on another network if that network is behind a firewall.

You can program the following items in a fax destination:

❖ **Fax number**

Registers the destination's fax number. You can enter a fax number using up to 128 digits. You must include every digit in the number.

❖ **SUB Code**

Registering a SUB Code allows you to use Confidential Transmission to send messages to the other fax machines which support a similar function called "SUB Code". See "SUB Code", Facsimile Reference.

❖ **SEP Code**

Registering a SEP Code allows you to use Polling Reception to receive faxes from the other fax machines which support Polling Reception. See "SEP Code", Facsimile Reference.

❖ **Line**

If the optional extra G3 interface unit is installed, you can select the line type per destination.

❖ **International TX mode**

When setting the International TX mode to **[On]**, the machine transmits more carefully by lowering transmission speed. However, communication times increase.

❖ **Fax header**

You can select to print a fax header on fax messages the other party receives. The default is "1st Name".

❖ **Label insertion**

Use label insertion to print information such as the destination name on the sheet printed out at the destination.

Data is printed as follows:

- **Destination Name**
The destination name specified in **[Fax Destination]** is printed with "To" before it at the top of the sheet.
- **Standard Message**

A registered two-line sentence is printed under "Destination Name".

To use this function, set Label Insertion to **[On]** when programming fax destinations and also press **[Label Insertion]** when sending fax documents.

Fax header and label insertion are also printed when sending by e-mail using the fax function.

You can program a standard message other than those registered in the machine. See "Programming, Changing, and Deleting Standard Messages", Facsimile Reference

You can program the following items in an IP-Fax Destination:

❖ **IP-Fax**

Register the IP-Fax destination. You can register the name using up to 128 characters. You must make this setting when using IP-Fax.

This setting only works if the IP-Fax function has been selected.

7

❖ **SUB Code**

Registering a SUB Code allows you to use Confidential Transmission to send messages to the other fax machines which support a similar function called "SUB Code". See "SUB Code", Facsimile Reference.

❖ **SEP Code**

Registering a SEP Code allows you to use Polling Reception to receive faxes from the other fax machines which support Polling Reception. See "SEP Code", Facsimile Reference.

❖ **Select Protocol**

Select the protocol for the IP-Fax transmission.

This setting only works if the IP-Fax function has been selected.

 **Reference**

p.255 "Registering Names to a Group"

p.265 "Registering a Protection Code"

Fax Destination

This section describes how to register a fax number.

Registering a Fax Destination

- 1 Press [System Settings].



- 2 Press [Administrator Tools].
- 3 Press [Address Book Management].
- 4 Check that [Program / Change] is selected.
- 5 Select the name whose fax destination you want to register. Press the name key, or enter the registered number using the number keys.
- 6 Press [Fax Dest.].
- 7 Enter the fax number using the number keys, and then press [OK] under Facsimile No..



- 8 Specify optional settings such as "SUB Code", "SEP Code", and "International TX mode".
- 9 Press [OK].

 **Note**

- When a group is registered, you can also add this fax destination to the group. For details about registering group, see "Registering Names to a Group".
- To register the name, see Registering Names".

 **Reference**

- p.209 "Registering Names"
- p.225 "Using a Fax Destination as a sender"
- p.225 "To change the line"
- p.226 "To change the SUB Code"
- p.226 "To change the SEP Code"
- p.226 "To set the International TX Mode"
- p.226 "To select the fax header"
- p.227 "To set label insertion"
- p.256 "Registering Names to a Group"

Changing a Fax Destination

1 Press [System Settings].



2 Press [Administrator Tools].

3 Press [Address Book Management].

4 Check that [Program / Change] is selected.

5 Select the name whose fax destination you want to change.

Press the name key, or enter the registered number using the number keys.

You can search by the registered name, user code, fax number, folder name, e-mail address, or IP-Fax destination.

6 Press [Fax Dest.].

7 Change the settings.

8 Press [OK].

 **Note**

- To change the name, key display and title, see “Changing a Registered Name”.

 **Reference**

- p.210 “Changing a Registered Name”
- p.225 “To change the fax number”
- p.225 “To change the line”
- p.226 “To change the SUB Code”
- p.226 “To change the SEP Code”
- p.226 “To set the International TX Mode”
- p.226 “To select the fax header”
- p.227 “To set label insertion”

Using a Fax Destination as a sender

1 Press [Protection].

2 Press [Sender] on the right side of Use Name as.

To change the fax number

1 Press [Change] under Facsimile No..

2 Enter the new fax number using the number keys, and then press [OK].

To change the line

1 Press [Select Line].

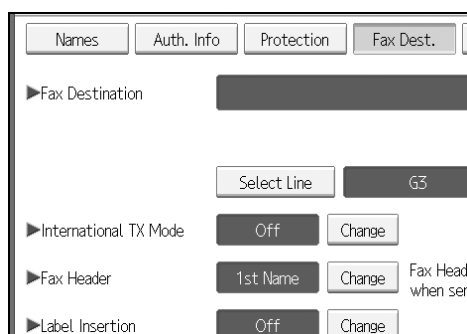

2 Select the line, and then press [OK].

To change the SUB Code

- 1** Press [Adv. Features], and then press [SUB Code].
- 2** Press [Change] under TX SUB Code.
- 3** Enter the new SUB Code, and then press [OK].
- 4** To change the password, press [Change] under Password (SID).
- 5** Enter the new password, and then press [OK].
- 6** Press [OK].

To change the SEP Code

- 1** Press [Adv. Features], and then press [SEP Code].
- 2** Press [Change] under RX SEP Code.
- 3** Enter the new SEP Code, and then press [OK].
- 4** To change the password, press [Change] under Password (PWD).
- 5** Enter the new password, and then press [OK].
- 6** Press [OK].

To set the International TX Mode

- 1** Press [Change] under International TX Mode.
- 2** Select [Off] or [On], and then press [OK].

To select the fax header

You can register the fax header in Program Fax Information in the system settings for Facsimile Features.

- 1** Press [Change] under Fax Header.
- 2** Select [1st Name] or [2nd Name], and then press [OK].

 **Reference**

p.143 "Registering Fax Information"

To set label insertion

When Label Insertion is set to ON, the receiver's name and standard messages are printed on the fax message when it is received at the other end.

- 1** Press [Change] under Label Insertion.
- 2** Press [On].
- 3** Press [Change] under Line 2.
- 4** Select the new standard message or press [Manual Entry] to enter the new message.
- 5** Enter the new message, and then press [OK].
- 6** Press [OK].
- 7** Press [Change] under Line 3.
- 8** Select the new standard message, and then press [OK].
- 9** Press [OK].

 **Note**

- To change the name, key display and title, see "Changing a Registered Name".

 **Reference**

p.210 "Changing a Registered Name"

Deleting a Fax Destination

 **Important**

- If you delete a destination that is a specified delivery destination, messages to its registered Personal Box, for example, cannot be delivered. Be sure to check the settings in the fax function before deleting any destinations.

- 1** Press [System Settings].



- 2** Press [Administrator Tools].

3 Press [Address Book Management].

4 Press [Delete].

5 Select the name whose fax destination you want to delete.

Press the name key, or enter the registered number using the number keys.

You can search by the registered name, user code, fax number, folder name, e-mail address, or IP-Fax destination.

6 Press [Fax Dest.].

7 Press [Change] under Facsimile No..

8 Press [Delete All].



9 Press [OK] twice.

10 Press the [User Tools/Counter] key.

 **Note**

- To delete the name, key display, and title, see “Deleting a Registered Name”.

 **Reference**

p.211 “Deleting a Registered Name”

IP-Fax Destination

This section describes how to register a IP-Fax destination.

Note

- For details about sending an IP-Fax, "Sending by IP-Fax", Facsimile Reference.

Reference

"Sending by IP-Fax", Facsimile Reference

Registering an IP-Fax Destination

- 1** Press [System Settings].



- 2** Press [Administrator Tools].

- 3** Press [Address Book Management].

- 4** Check that [Program / Change] is selected.

- 5** Select the name whose IP-Fax destination you want to register.

Press the name key, or enter the registered number using the number keys.

- 6** Press [Fax Dest.].

- 7** Press [Select Line], and then select [H.323] or [SIP].

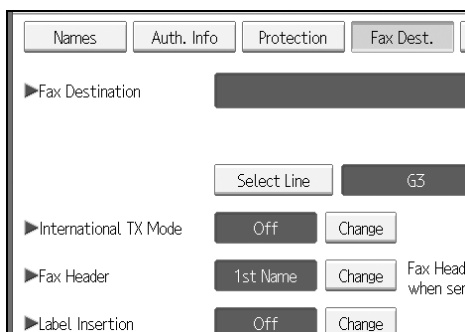

- 8** Press [Change] under "Fax Destination".

9 Enter the IP-Fax destination.

10 Press [OK] twice.

 **Note**

To register the name, see "Registering Names".

 **Reference**

p.209 "Registering Names"

p.213 "Registering a User Code"

p.255 "Registering Names to a Group"

"Entering Text", About This Machine

Changing a Registered IP-Fax Destination

1 Press [System Settings].



2 Press [Administrator Tools].

3 Press [Address Book Management].

4 Check that [Program / Change] is selected.

5 Select the name whose IP-Fax destination you want to change.

You can search by the registered name, user code, fax number, folder name, e-mail address, or IP-Fax destination.

6 Press [Fax Dest.].

7 Press [Change] under "Fax Destination".

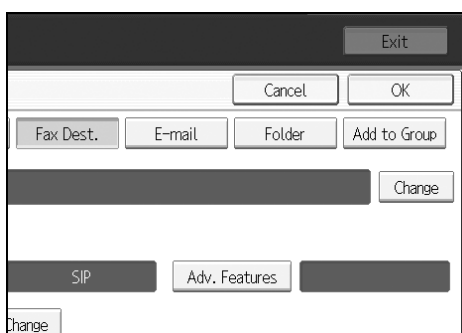

8 Enter the new destination, and then press [OK].

9 Press [OK].

10 Press [OK].

 **Note**

- To change the name, key display and title, see "Changing a Registered Name".

 **Reference**

p.210 "Changing a Registered Name"
"Entering Text", About This Machine

7

Using the IP-Fax Destination as the sender

1 Press [Protection].

2 Press [Sender] under [Use Name as].

To change the IP-Fax Destination

1 Press [Change] under [Use Name as].

2 Enter the new destination, and then press [OK].

To select the protocol

1 Press [Select Line].

2 Select [H.323] or [SIP].

To program the SUB Code

- 1** Press [Adv. Features], and then press [SUB Code].
 - 2** Press [Change] under TX SUB Code.
 - 3** Enter the SUB Code, and then press [OK].
 - 4** To enter a password, press [Change] under Password (SID).
 - 5** Enter a password using the number keys, and then press [OK].
 - 6** Press [OK].
-

To program the SEP Code

- 1** Press [Adv. Features], and then press [SUB Code].
 - 2** Press [Change] under RX SEP Code.
 - 3** Enter a SEP Code using the number keys, and then press [OK].
 - 4** To enter a password, press [Change] under Password (PWD).
 - 5** Enter a password using the number keys, and then press [OK].
 - 6** Press [OK].
-

To set the International TX Mode

- 1** Press [Change] under International TX Mode.
 - 2** Select [Off] or [On], and then press [OK].
-

To select the fax header

- 1** Press [Change] under Fax Header.
 - 2** Select [1st Name] or [2nd Name], and then press [OK].
-

Deleting a Registered IP-Fax Destination

If you delete a destination that is a specified delivery destination, messages to its registered Personal Box, for example, cannot be delivered. Be sure to check the settings in the fax function before deleting any destinations.

- 1** Press [System Settings].

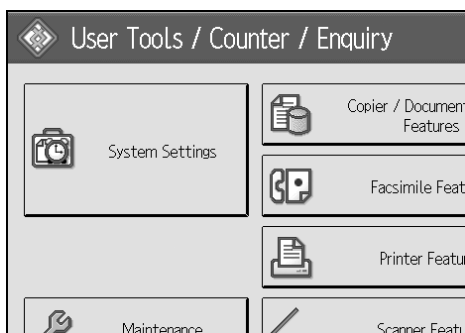

- 2** Press [Administrator Tools].
- 3** Press [Address Book Management].
- 4** Press [Delete].
- 5** Select the name whose IP-Fax destination you want to delete. Press the name key, or enter the registered number using the number keys.
You can search by the registered name, user code, fax number, folder name, e-mail address, or IP-Fax destination.
- 6** Press [Fax Dest.].
- 7** Press [Change] under "Fax Destination".
- 8** Press [Delete All].
- 9** Press [OK] twice.
- 10** Press the [User Tools/Counter] key.

Note

- To change the name, key display and title, see "Changing a Registered Name".

Reference

p.210 "Changing a Registered Name"

E-mail Destination

Register e-mail destinations so you do not need to enter an e-mail address every time, and can send scan files from scanner or fax function by email.

- It is easy to select the e-mail destination if you register "Name" and "Key Display" as the e-mail destination.
- You can register e-mail destinations as a group.
- You can use the e-mail address as the sender's address when sending scan files in scanner mode. If you want to do this, set a protection code on the sender address to prevent unauthorized access.

Note

- ❑ You can select an e-mail address from an LDAP server, and then register it in the Address Book. See "Sending Scan File by E-mail", Scanner Reference.
- ❑ You can set the machine to send a Transmission Result Report by email whenever a transmission is sent. See Facsimile Reference You can set the machine to send a Transmission Result Report by email whenever a transmission is sent. See Facsimile Reference.

Reference

p.265 "Registering a Protection Code"

7

Registering an E-mail Destination

- 1 Press [System Settings].

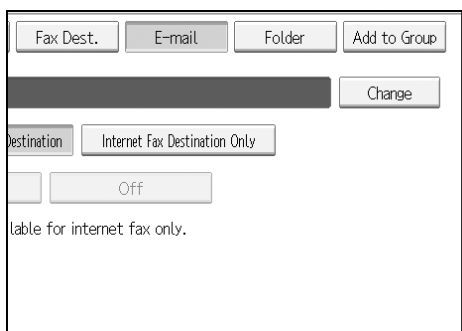

- 2 Press [Administrator Tools].
- 3 Press [Address Book Management].
- 4 Check that [Program / Change] is selected.
- 5 Select the name whose e-mail address you want to register. Press the name key, or enter the registered number using the number keys.
- 6 Press [E-mail].

7 Press [Change].**8** Enter the e-mail address.**9** Press [OK].**10** Select [E-mail / Internet Fax Destination] or [Internet Fax Destination Only].**11** If you want to use internet fax, specify whether or not to use " Send via SMTP Server".**12** Press [OK].**Note**

- You can enter up to 128 characters for the e-mail address.
- To register the name, see "Registering Names".

Reference

- p.209 "Registering Names"
- p.213 "Registering a User Code"
- p.256 "Registering Names to a Group"

Changing an E-mail Destination

- 1 Press [System Settings].



- 2 Press [Administrator Tools].

- 3 Press [Address Book Management].

- 4 Check that [Program / Change] is selected.

- 5 Select the name whose e-mail address you want to change.

Press the name key, or enter the registered number using the number keys.

You can search by the registered name, user code, fax number, folder name, e-mail address, or IP-Fax destination.

- 6 Press [E-mail].

- 7 Press [Change] under E-mail Address.

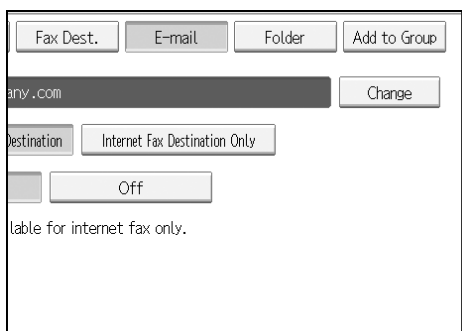

- 8 Enter the e-mail address, and then press [OK].

- 9 Press [OK].

Note

To change the name, key display and title, see "Changing a Registered Name".

Reference

p.210 "Changing a Registered Name"
"Entering Text", About This Machine

Using the e-mail address as the sender

- 1** Press [Protection].
 - 2** Press [Sender] under [Use Name as].
-

Deleting an E-mail Destination

- 1** Press [System Settings].



- 2** Press [Administrator Tools].
- 3** Press [Address Book Management].
- 4** Press [Delete].
- 5** Select the name whose e-mail address you want to delete.

Press the name key, or enter the registered number using the number keys.

You can search by the registered name, user code, fax number, folder name, e-mail address, or IP-Fax destination.

- 6** Press [E-mail].
- 7** Press [Change] under E-mail Address.
- 8** Press [Delete All].
- 9** Press [OK] twice.
- 10** Press the [User Tools/Counter] key.

 **Note**

- To delete the name, key display, and title, see "Deleting a Registered Name".

 **Reference**

p.211 "Deleting a Registered Name"

Registering Folders

By registering a shared folder, you can send scan files to it directly.

There are three types of protocol you can use:

- SMB
For sending files to shared Windows folders.
- FTP
Use when sending files to an FTP server.
- NCP
Use when sending files to an Net- Ware server.

 **Note**

- For details about protocols, server names, and folder levels, consult your network administrator.
- You can prevent unauthorized users from accessing folders from the machine. See "Registering a Protection Code".
- You can only select either SMB, FTP, or NCP. If you change protocol after finishing your settings, all previous entries are cleared.

Using SMB to Connect

 **Note**

- To register a folder in an FTP server, see "Using FTP to Connect".
- To register a folder in an NetWare server, see "Using NCP to Connect".

 **Reference**

- p.244 "Using FTP to Connect"
- p.249 "Using NCP to Connect"

Registering a Folder

1 Press [System Settings].



2 Press [Administrator Tools].

- 3** Press [Address Book Management].
- 4** Check that [Program / Change] is selected.
- 5** Select the name whose folder you want to register. Press the name key, or enter the registered number using the number keys.
- 6** Press [Auth. Info], and then press [Next].

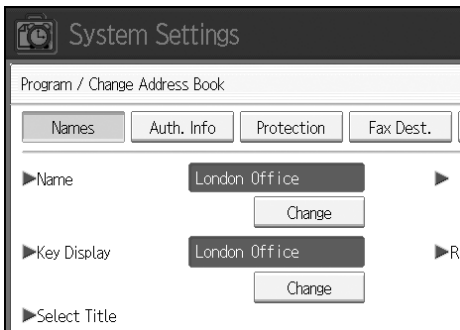

- 7** Press [Specify Other Auth. Info] on the right side of Folder Authentication.
- 8** Press [Change] under Login User Name.
- 9** Enter the login user name, and then press [OK].
- 10** Press [Change] under Login Password.
- 11** Enter the password, and then press [OK].
- 12** Enter the password again to confirm, and then press [OK].
- 13** Press [Folder].
- 14** Press [SMB].

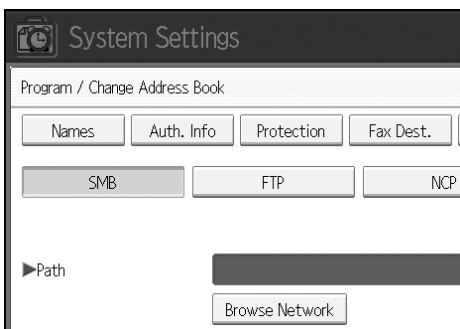

- 15** Press [Connection Test] to check the path is set correctly.
- 16** Press [Exit].
- 17** Press [OK].
- 18** Press [Exit].

 **Note**

- To register the name, see “Registering Names”.
- You can enter up to 64 characters for the user name.
- You can enter up to 64 characters for the password.
- You can enter a path using up to 128 characters.
- To specify a folder, you can either enter the path manually or locate the folder by browsing the network.
- If the connection test fails, check the settings, and then try again.
- When **[Do not Specify]** is selected, the SMB User Name and SMB Password that you have specified in Default User Name / Password (Send) of File Transfer settings applies.
- If User Authentication is specified, contact your administrator.

 **Reference**

p.209 “Registering Names”

p.240 “To locate the folder manually”

p.241 “To locate the folder using Browse Network”

To locate the folder manually

7

1 Press **[Change]** under Path.

2 Enter the path where the folder is located.

3 Press **[OK]**.

If the format of the entered path is not correct, a message appears. Press **[Exit]**, and then enter the path again.

 **Note**

- Enter the path using this format: “\\ServerName\Share-Name\PathName”.
- You can also enter an IPv4 address.
- You can enter a path using up to 128 characters.

To locate the folder using Browse Network

1 Press **[Browse Network]**.

The client computers sharing the same network as the machine appear. Network display only lists client computers you are authorized to access.

2 Select a client computer.

Shared folders under it appear.

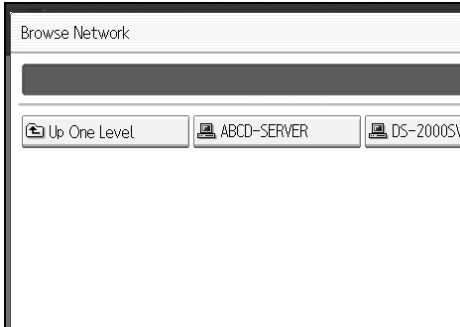

You can press **[Up One Level]** to switch between levels.

3 Select the folder you want to register.

4 **[OK]**.

If a Login Screen Appears

This section explains how to log on to the machine if the login screen appears when you try to access a folder by browsing the network.

If you have not specified folder authentication, or if an incorrect user name or password has been entered for folder authentication, the login screen appears.

1 Enter the login user name, and then press **[OK]**.

Enter the login user name specified for folder authentication.

2 Enter the password, and then press **[OK]**.

The path to the selected folder appears.

If a message appears, press **[Exit]**, and then enter the login user name and password again.

Changing a Folder

1 Press [System Settings].



2 Press [Administrator Tools].

3 Press [Address Book Management].

4 Check that [Program / Change] is selected.

5 Select the name whose folder you want to change.

Press the name key, or enter the registered number using the number keys.

You can search by the registered name, user code, fax number, folder name, e-mail address, or IP-Fax destination.

6 Press [Folder].

7 Select the items you want to change.

When specifying a folder, enter the path directly or select it by referencing the network. For more information, see "To locate the folder manually" and "Using Browse Network to locate the folder".

8 Press [Connection Test] to check the path is set correctly.

9 Press [OK].

10 Press [Exit].

 **Note**

- To change the name, key display and title, see "Changing a Registered Name".

 **Reference**

p.210 "Changing a Registered Name"

To change the protocol

- 1 Press [FTP] or [NCP].

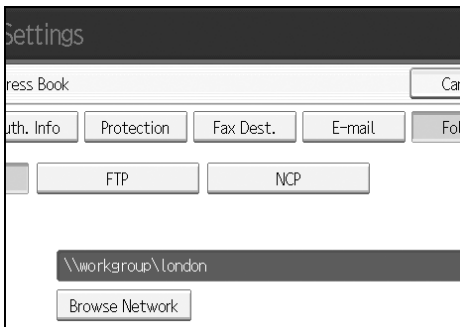

- 2 A confirmation message appears. Press [Yes].

Changing the protocol will clear all settings made under the previous protocol.

- 3 Enter each item again.

Reference

p.244 "Registering a Folder"

Deleting a registered folder

7

- 1 [System Settings].



- 2 Press [Administrator Tools].
- 3 Press [Address Book Management].
- 4 Press [Delete].
- 5 Select the name whose folder you want to delete.

Press the name key, or enter the registered number using the number keys.

You can search by the registered name, user code, fax number, folder name, e-mail address, or IP-Fax destination.

6 Press [Folder].

7 Press the protocol which is not currently selected.

A confirmation message appears.

8 Press [Yes].

9 Press [OK].

10 Press [Exit].

 **Note**

- To delete the name, key display, and title, see “Deleting a Registered Name”.

 **Reference**

p.211 “Deleting a Registered Name”

Using FTP to Connect

 **Note**

- To register a shared folder configured in Windows, see “Using SMB to Connect”.
- To register a folder in an NetWare server, see “Using NCP to Connect”.

 **Reference**

p.238 “Using SMB to Connect”

p.249 “Using NCP to Connect”

Registering a Folder

1 Press [System Settings].

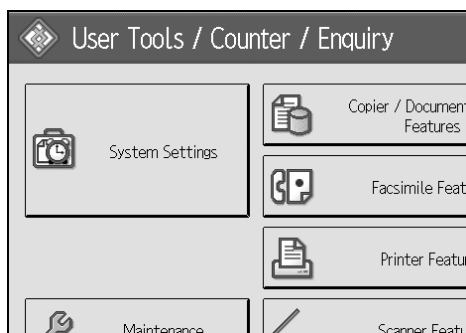

2 Press [Administrator Tools].

3 Press [Address Book Management].

4 Check that [Program / Change] is selected.

5 Select the name whose folder you want to register.

You can search by the registered name, user code, fax number, folder name, e-mail address, or IP-Fax destination.

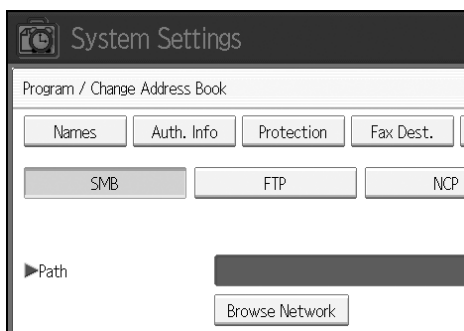
6 Press [Auth. Info], and then press [Next].**7** Press [Specify Other Auth. Info] on the right side of Folder Authentication.**8** Press [Change] under Login User Name.**9** Enter the login user name, and then press [OK].**10** Press [Change] under Login Password.**11** Enter the password, and then press [OK].**12** Enter the password again to confirm, and then press [OK].**13** Press [Folder].**14** Press [FTP].**15** Press [Change] under Server Name.**16** Enter the server name, and then press [OK].**17** Press [Change] under Path.**18** Enter the path.**19** Press [OK].**20** Press [Change] under "Port No."**21** Enter Port No..**22** Press [Connection Test] to check the path is set correctly.**23** Press [Exit].**24** Press [OK].**25** Press [Exit].

 **Note**

- To register the name, see "Registering Names".
- You can enter up to 64 characters for the user name.
- You can enter up to 64 characters for the password.
- You can enter a server name using up to 64 characters.
- You can enter an absolute path, using this format: "/user/ home/user-name"; or a relative path, using this format: "directory/sub-directory".
- If you leave the path blank, the login directory is assumed to be the current working directory.
- You can also enter an IPv4 address.
- You can enter a path using up to 128 characters.
- To change the port number, press **[Change]** under Port No.. Enter the port number using the number keys, and then press **[#]**.
- You can enter 1 to 65535.
- If the connection test fails, check the settings, and then try again.
- When **[Do not Specify]** is selected, the FTP User Name and FTP Password that you have specified in Default User Name / Password (Send) of File Transfer settings applies. For details, see "File Transfer".
- If User Authentication is specified, contact your administrator.

 **Reference**

- p.209 "Registering Names"
- p.240 "To locate the folder manually"
- p.241 "To locate the folder using Browse Network"

7

Changing a Folder

1 Press **[System Settings]**.



2 Press **[Administrator Tools]**.

3 Press **[Address Book Management]**.

4 Check that **[Program / Change]** is selected.

- 5** Select the name whose folder you want to change, and then press **[Folder]**.
Press the name key, or enter the registered number using the number keys.
You can search by the registered name, user code, fax number, folder name, e-mail address, or IP-Fax destination.
- 6** Press **[Folder]**.
- 7** Select the items you want to change.
- 8** Press **[Connection Test]** to check the path is set correctly.
- 9** Press **[OK]**.
- 10** Press **[Exit]**.

 **Note**

- To change the name, key display and title, see “Changing a Registered Name”.

 **Reference**

p.210 “Changing a Registered Name”

To change the protocol

- 1** Press **[SMB]**, or **[NCP]**.

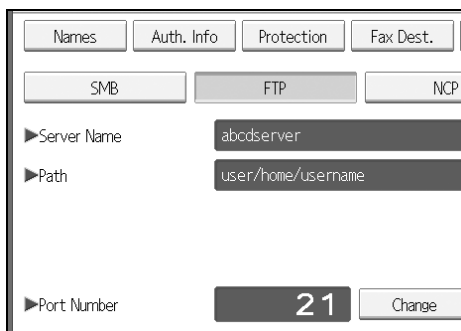

The screenshot shows a configuration menu with the following elements:

- Tabs: Names, Auth. Info, Protection, Fax Dest.
- Protocol buttons: SMB, FTP, NCP
- Server Name: abcdserver
- Path: user/home/username
- Port Number: 21 (with a Change button)

- 2** A confirmation message appears. Press **[Yes]**.
Changing the protocol will clear all settings made under the previous protocol.
- 3** Enter each item again.

 **Reference**

p.238 “Registering a Folder”

Changing items under FTP

- 1** Press [Change] under Port No.
- 2** Enter the new port number, and then press [#].
- 3** Press [Change] under Server Name.
- 4** Enter the new server name, and then press [OK].
- 5** Press [Change] under "Path".
- 6** Enter the new path, and then press [OK].

Deleting a Folder

- 1** Press [System Settings].



- 2** Press [Administrator Tools].
- 3** Press [Address Book Management].
- 4** Press [Delete].
- 5** Select the name whose folder you want to delete.

Press the name key, or enter the registered number using the number keys.

You can search by the registered name, user code, fax number, folder name, e-mail address, or IP-Fax destination.

- 6** Press [Folder].
- 7** Press the protocol which is not currently selected.
A confirmation message appears.

8 Press [Yes].

9 Press [OK].

10 Press [Exit].

Note

- ☐ To delete a name entirely, see “Deleting a Registered Name”.

Reference

p.211 “Deleting a Registered Name”

Using NCP to Connect

Note

- ☐ To register a shared folder configured in Windows, see “Using SMB to Connect”
- ☐ To register a folder in an FTP server, see “Using FTP to Connect”

Reference

p.238 “Using SMB to Connect”

p.244 “Using FTP to Connect”

Registering a Folder

1 Press [System Settings].



2 Press [Administrator Tools].

3 Press [Address Book Management].

4 Check that [Program / Change] is selected.

5 Press the name you want to register or enter the registered number using the number keys.

You can search by the registered name, user code, fax number, folder name, e-mail address, or IP-Fax destination.

6 Press [Auth. Info], and then press [Next].

7 Press [Specify Other Auth. Info] on the right side of Folder Authentication.

8 Press [Change] under Login User Name.

- 9 Enter the login user name, and then press [OK].
- 10 Press [Change] under Login Password.
- 11 Enter the password, and then press [OK].
- 12 Enter the password again to confirm, and then press [OK].
- 13 Press [Folder].
- 14 Press [NCP].
- 15 Select "Connection Type".
If you want to specify a folder in an NDS tree, press [NDS]. If you want to specify a folder on a NetWare server, press [Bindery].
- 16 Specify the folder.
- 17 Press [OK].
- 18 Press [Exit].

Note

- To register the name, see "Registering Names".
- You can enter up to 64 characters for the user name.
- You can enter up to 64 characters for the password.
- If you have set "Connection Type" to [NDS], enter the user name followed by the name of the context where the user object is located. If the user name is "user" and the context name is "context", enter "user.context"
- To specify a folder, you can either enter the path manually or locate the folder by browsing the network.
- When [Do not Specify] is selected, the NCP User Name and NCP Password that you have specified in Default User Name / Password (Send) of File Transfer settings applies. For details, see "File Transfer".
- If User Authentication is specified, contact your administrator.

Reference

- p.209 "Registering Names"
- p.251 "To locate the folder manually"
- p.251 "To locate the folder using Browse Network"
- "Entering Text", About This Machine

To locate the folder manually

- 1** Press **[Change]** under **Path**.
- 2** Enter the path where the folder is located.
- 3** **[OK]**.
- 4** Press **[Connection Test]** to check the path is set correctly.
- 5** Press **[Exit]**.

 **Note**

- If you set "Connection Type" to **[NDS]**, and if the NDS tree name is "tree", the name of the context including the volume is "context", the volume name is "volume" and the folder name is "folder", then the path will be "\\tree\volume.context\folder".
- If you set "Connection Type" to **[Bindery]**, and if the Net-Ware server name is "server", the volume name is "volume" and the folder name is "folder", then the path will be "\\server\volume\folder".
- You can enter a path using up to 128 characters.
- If the connection test fails, check the settings, and then try again.

To locate the folder using Browse Network

- 1** Press **[Browse Network]**.
- 2** If you have set "Connection Type" to **[NDS]**, a list of items in the NDS tree appears. If you have set "Connection Type" to **[Bindery]**, a list of items on the NetWare server appears.
- 3** Search for the destination folder in the NDS tree or NetWare server.
You can press **[Up One Level]** to switch between levels.
- 4** Select the folder you want to register.
- 5** **[OK]**.

 **Note**

- Only the folders you are allowed to access appear in **[Browse Network]**.
- If the languages used on the machine and the destination you want to view differ, the items in the list may not appear correctly.
- Up to 100 items can be displayed in the list.

Changing a registered folder

1 Press **[System Settings]**.



2 Press **[Administrator Tools]**.

3 Press **[Address Book Management]**.

4 Check that **[Program / Change]** is selected.

5 Select the user of the registered folder you want to change.

Press the name key, or enter the registered number using the number keys.

You can search by the registered name, user code, fax number, folder name, e-mail address, or IP-Fax destination.

6 Press **[Folder]**.

7 Select **"Connection Type"**.

If you want to specify a folder in an NDS tree, press **[NDS]**. If you want to specify a folder on a NetWare server, press **[Bindery]**.

8 Specify the folder.

To specify a folder, you can either enter the path manually or locate the folder by browsing the network.

9 Press **[Connection Test]** to check the path is set correctly.

10 Press **[OK]**.

11 Press **[Exit]**.

Note

- To change the name, key display and title, see "Changing a Registered Name".

Reference

p.210 "Changing a Registered Name"

To change the protocol

1 Press [SMB], or [FTP].

2 A confirmation message appears. Press [Yes].

Changing the protocol will clear all settings made under the previous protocol.

3 Enter each item again.

 **Reference**

p.238 "Registering a Folder"

p.244 "Registering a Folder"

Deleting a Folder

1 Press [System Settings].

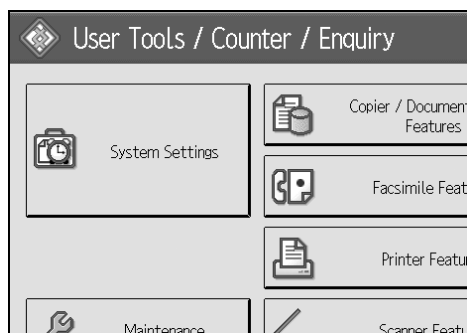

2 Press [Administrator Tools].

3 Press [Address Book Management].

4 Press [Delete].

5 Select a user of the folder you want to delete.

Press the name key, or enter the registered number using the number keys.

You can search by the registered name, user code, fax number, folder name, e-mail address, or IP-Fax destination.

6 Press [Folder].

7 Press the protocol which is not currently selected.

A confirmation message appears.

8 Press [Yes].

9 Press [OK].

10 [Exit].

 **Note**

To delete a name entirely, see “Deleting a Registered Name”.

 **Reference**

p.211 “Deleting a Registered Name”

Registering Names to a Group

You can register names to a group to enable easy management of e-mail addresses and folders for each group.

To add names to a group, the groups must be registered beforehand.

Important

- When using Scan to Folder function, you cannot send scan files to a group with over 50 folders registered.
- The maximum number of destinations registerable to a group is 500.

Note

- You can set a protection code to prevent unauthorized access to the folders registered in a group. For details, see "Registering a Protection Code".

Reference

p.265 "Registering a Protection Code"

Registering a Group

- 1** Press [System Settings].

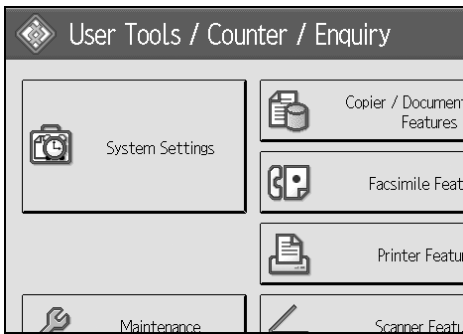

- 2** Press [Administrator Tools].
- 3** Press [Address Book: Program / Change / Delete Group].
- 4** Check that [Program / Change] is selected.
- 5** Press [New Program].

6 Press **[Change]** under **Group Name**.

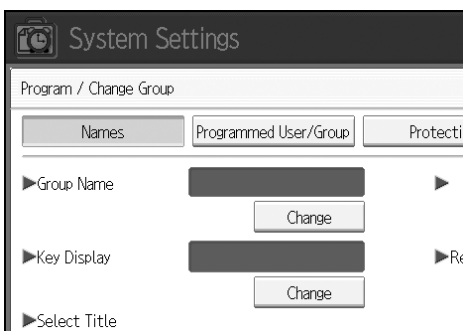

7 Enter the group name, and then press **[OK]**.

The Key Display name is set automatically.

8 Press the title key under **Select Title**, if necessary.

9 When you want to change the key display, press **[Change]** under **Key Display**. Enter the key display, and then press **[OK]**.

10 Press **[OK]**.

Note

- The keys you can select are as follows:
 - **[Frequent]**: Added to the page that is displayed first.
 - **[AB], [CD], [EF], [GH], [IJK], [LMN], [OPQ], [RST], [UVW], [XYZ], [1] to [10]**... Added to the list of items in the selected title.
- You can select **[Frequent]** and one more page for each title.

Reference

"Entering Text", About This Machine

Registering Names to a Group

You can put names that have been registered in the Address Book into a group. When registering new names, you can also register groups at the same time.

1 Press **[System Settings]**.



- 2** Press [Administrator Tools].
- 3** Press [Address Book Management].
- 4** Check that [Program / Change] is selected.
- 5** Select the name to register in a group.

Press the name key, or enter the registered number using the number keys.
You can search by the registered name, user code, fax number, folder name, e-mail address, or IP-Fax destination.

- 6** Press [Add to Group].
- 7** Select a group to which you want to add the name to.

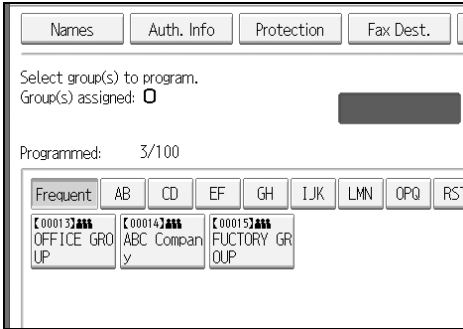

The group key that you have selected becomes highlighted, and the name is added to it.

7

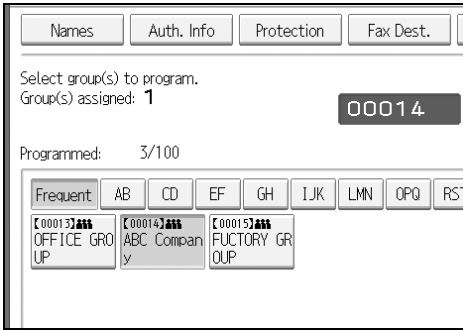

- 8** Press [OK].

Adding a Group to Another Group

You can add a group to another group.

- 1 Press **[System Settings]**.

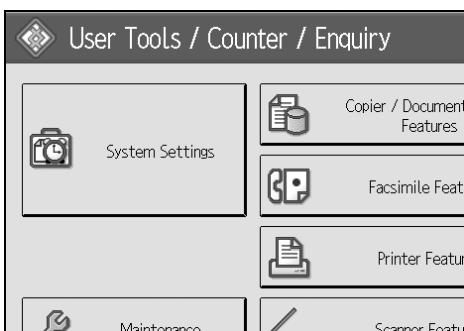

- 2 Press **[Administrator Tools]**.
- 3 Press **[Address Book: Program / Change / Delete Group]**.
- 4 Check that **[Program / Change]** is selected.
- 5 Select the group that you want to put into another group.

Press the group key, or enter the registered number using the number keys.

You can search by the registered name, user code, fax number, folder name, e-mail address, or IP-Fax destination.

- 6 Press **[Add to Group]**.

7 Select the group which you want to add to.

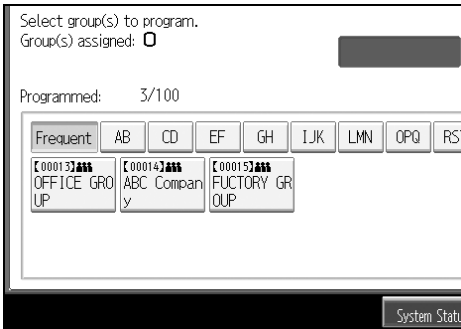

The group key that you have selected becomes highlighted, and the group is added to it.

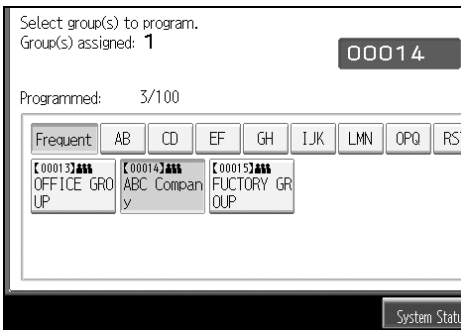

8 Press [OK].

7

Displaying Names Registered in a Group

You can check the names or groups registered in each group.

1 Press [System Settings].



2 Press [Administrator Tools].

3 Press [Address Book: Program / Change / Delete Group].

4 Check that [Program / Change] is selected.

5 Select the group where the members you want to check is egistered.

You can search by the registered name, user code, fax number, folder name, e-mail address, or IP-Fax destination.

6 Press [Programmed User/Group].

All the names registered will be displayed.

7 Press [OK].

Removing a Name from a Group

1 Press [System Settings].



2 Press [Administrator Tools].

3 Press [Address Book Management].

4 Check that [Program / Change] is selected.

5 Select the name to remove from a group.

Press the name key, or enter the registered number using the number keys.

You can search by the registered name, user code, fax number, folder name, e-mail address, or IP-Fax destination.

6 Press [Add to Group].

7 Select the group from which you want to remove the name.

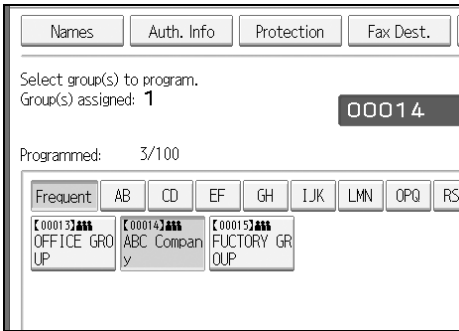

The group key that you have selected becomes highlighted, and the name is added to it.

8 Press [OK].

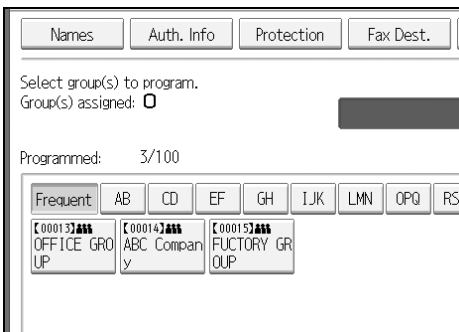

7

Deleting a Group Within Atnother Group

1 Press [System Settings].



2 Press [Administrator Tools].

3 Press [Address Book: Program / Change / Delete Group].

4 Check that [Program / Change] is selected.

5 Select the group that you want to delete from.

Press the group key, or enter the registered number during the number keys. You can search by the registered name, user code, fax number, folder name, e-mail address, or IP-Fax destination.

6 Press [Add to Group].

The keys of groups in which the group is registered appear highlighted.

7 Select the group that you want to delete from.

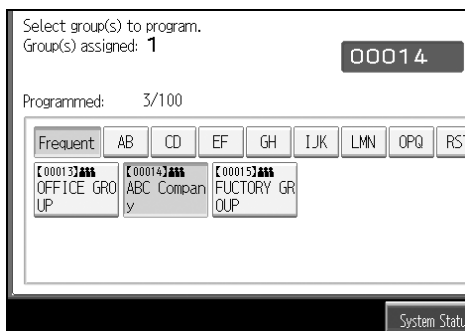

The group key is deselected and the group is deleted from it.

8 [OK].

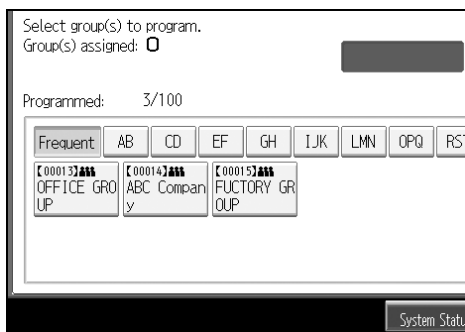

7

Changing a Group Name

- 1 Press [System Settings].



- 2 Press [Administrator Tools].
- 3 Press [Address Book: Program / Change / Delete Group].
- 4 Check that [Program / Change] is selected.
- 5 Press the group key you want to change.

You can search by the registered name, user code, fax number, folder name, e-mail address, or IP-Fax destination.

- 6 To change the group name and key display, press [Change] under Group Name or Key Display.



- 7 Enter the new group name or key display, and then press [OK].
- 8 To change the title, press the title key under Select Title.
- 9 To change the registration number, press [Change] under Registration No..
- 10 Enter the new registration number using the number keys.
- 11 Press the [#] key.
- 12 Press [OK].

Deleting a Group

- 1** Press [System Settings].

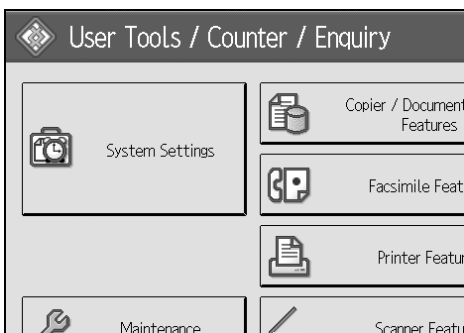

- 2** Press [Administrator Tools].
- 3** Press [Address Book: Program / Change / Delete Group].
- 4** Press [Delete].
- 5** Press [Yes].
- 6** Press a group key you want to delete.

7

You can search by the registered name, user code, fax number, folder name, e-mail address, or IP-Fax destination.

- 7** Press [Yes].

Registering a Protection Code

You can stop sender's names or folders being accessed by setting a protection code.

You can use this function to protect the following:

- Folders
You can prevent unauthorized access to folders.
- Sender's names
You can prevent misuse of sender's names.

Reference

p.213 "Registering a User Code"

Registering a Protection Code to a Single User

- 1** Press [System Settings].



- 2** Press [Administrator Tools].
- 3** Press [Address Book Management].
- 4** Check that [Program / Change] is selected.
- 5** Select the name whose protection code you want to register.

You can search by the registered name, user code, fax number, folder name, e-mail address, or IP-Fax destination.

6 Press **[Protection]**.

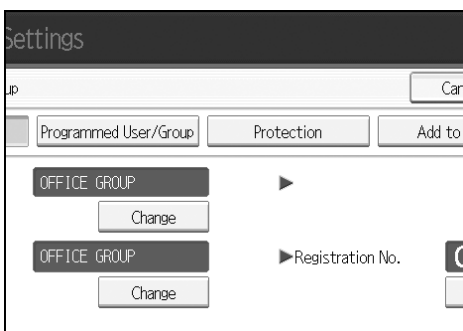

7 Press **[Destination]** or **[Sender]** under Use Name as.

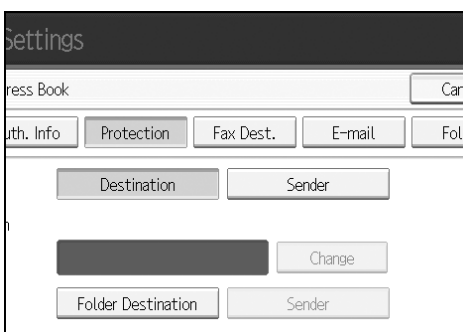

7

Both **[Destination]** and **[Sender]** can be selected at the same time.

8 Press **[Change]** under Protection Code.

9 Enter a protection code using the number keys, and then press **[#]**.

10 Press **[OK]**.

11 Press **[Exit]**.

 **Note**

- Specify a protection code of up to eight digits. You can also specify "Protection" without specifying a protection code.

Registering a Protection Code to a Group User

- 1 Press [System Settings].

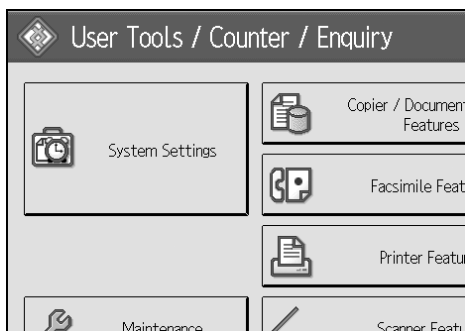

- 2 Press [Administrator Tools].
- 3 Press [Address Book: Program / Change / Delete Group].
- 4 Check that [Program / Change] is selected.
- 5 Press the group key you want to register or enter the registered number using the number keys.
- 6 Press [Protection].
- 7 Press [Folder Destination] under Protection Object.
- 8 Press [Change] under Protection Code.
- 9 Enter a protection code using the number keys, and then press the [#] key.
- 10 Press [OK].
- 11 Press [Exit].

 **Note**

- Specify a protection code of up to eight digits. You can also specify "Protection" without specifying a protection code.

Registering SMTP and LDAP Authentication

SMTP Authentication

For each user registered in the Address Book, you can register a login user name and login password to be used when accessing an SMTP server.

To use an SMTP server, you need to program it beforehand.

Important

- When [**Do not Specify**] is selected for SMTP Authentication, the User Name and Password that you have specified in SMTP Authentication of File Transfer settings applies. For details, see "File Transfer".

1 Press [**System Settings**].



2 Press [**Administrator Tools**].

3 Press [**Address Book Management**].

4 Check that [**Program / Change**] is selected.

5 Press the name you want to register or enter the registered number using the number keys

You can search by the registered name, user code, fax number, folder name, e-mail address, or IP-Fax destination.

6 Press [**Auth. Info**].

7 Press [**Specify Other Auth. Info**] on the right side of SMTP Authentication.

8 Press [Change] under Login User Name.

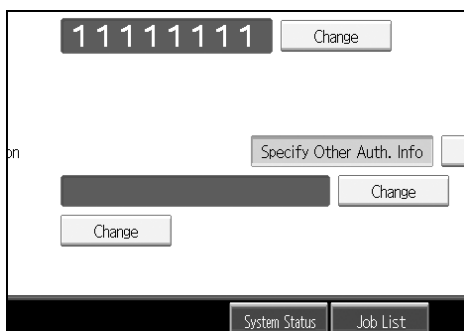

9 Enter the login user name, and then press [OK].

10 Press [Change] under Login Password.

11 Enter the password, and then press [OK].

12 Enter the password again to confirm, and then press [OK].

13 [OK].

Note

- To register the name, see "Registering Names".
- You can enter up to 191 characters for the user name.
- When using POP before SMTP Authentication, you can enter up to 63 characters.
- You can enter up to 64 characters for the password.
- To change the SMTP Authentication settings, repeat step **2** to **13**.

Reference

p.209 "Registering Names"

p.15 "Network Settings"

"Entering Text", About This Machine

LDAP Authentication

For each user registered in the Address Book, you can register a login user name and login password to be used when accessing an LDAP server.

To use an LDAP server, you need to program it beforehand. For details, see "LDAP Server Settings", Network Guide.

Important

- When **[Do not Specify]** is selected for LDAP Authentication, the User Name and Password that you have specified in Program / Change LDAP Server of Administrator Tools settings applies. For details, see "LDAP Server Settings".

1 Press [System Settings].

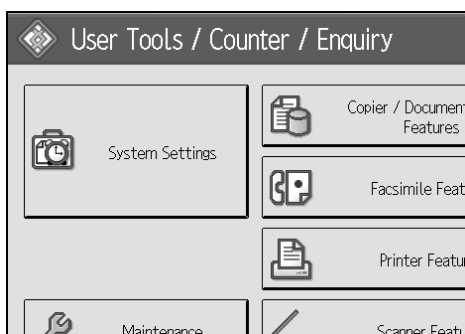

2 Press [Administrator Tools].

3 Press [Address Book Management].

4 Check that [Program / Change] is selected.

You can search by the registered name, user code, fax number, folder name, e-mail address, or IP-Fax destination.

5 Press the name you want to register or enter the registered number using the number keys.

6 Press [Auth. Info], and then press [Next].

7 Press [Specify Other Auth. Info] on the right side of LDAP Authentication.

8 Press [Change] under Login User Name.

The screenshot shows a configuration window with several fields. The 'Login User Name' field is highlighted with a dark background and has a 'Change' button to its right. Above it is the 'Login Password' field, also with a 'Change' button. To the right of these fields is a 'Specify Other Auth. Info' button. At the bottom of the window are two buttons: 'System Status' and 'Job List'.

9 Enter the login user name, and then press [OK].**10** Press [Change] under Login Password.**11** Enter the password, and then press [OK].**12** Enter the password again to confirm, and then press [OK].**13** Press [OK].**Note**

- To register the name, see "Registering Names".
- When **[Do not Specify]** is selected for LDAP Authentication, the User Name and Password that you have specified in Program / Change LDAP Server of Administrator Tools settings applies.
- You can enter up to 128 characters for the user name.
- To change the LDAP Authentication settings, repeat step **2** to **13**.

Reference

p.209 "Registering Names"

"Entering Text", About This Machine

8. Other User Tools

Initial settings allow you switch the language as well as checking the number of printed papers by displaying the counter.

For the details on how to access respective settings, see "Accessing User Tools (System Settings)".

Reference

p.3 "Accessing User Tools (System Settings)"

Maintenance

This section describes the user tools in Maintenance.

[Maintenance] allows correcting colour drift and gradient.

❖ **Auto Colour Calibration**

If a certain colour is strong or the colour of the copy differs from the original, adjust the yellow, magenta, cyan and black balance.

❖ **Colour Registration**

If the colour documents show registration shifting, perform automatic colour registration.

Note

For details about "Auto Colour Calibration" and "Colour Registration", see "Maintenance", Troubleshooting.

Reference

"Maintenance", Troubleshooting

Changing the Display Language

You can change the language used on the display. English is set as default.

1 Press [Français].

The language is changed to French.

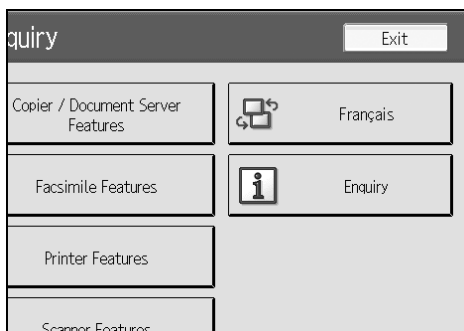

2 Press [Sortie].

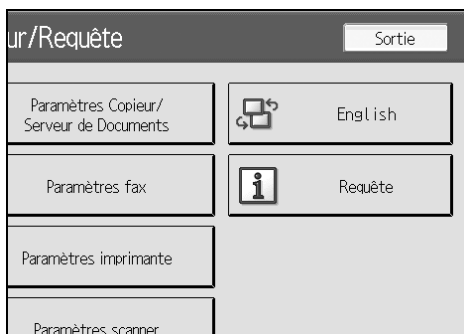

The menu appears in French.

Enquiry

The enquiry function lets you check the telephone numbers to contact for repairs, or ordering consumables such as toner. Be sure to contact your service engineer to verify the following:

❖ Consumables

- Telephone No. to order
- Toner
- Staple
- Staple (Centre)
- TX Stamp Name

❖ Machine Maintenance/Repair

- Telephone No.
- Serial No. of Machine

❖ Sales Representative

- Telephone No.

1 Press [Enquiry].

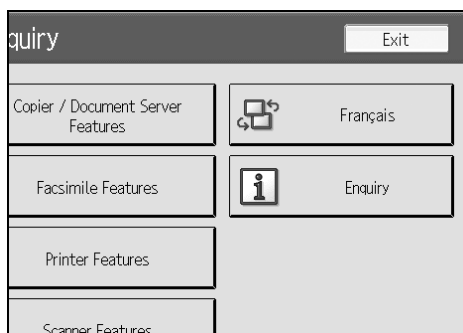

Enquiry information appears.

2 Press [Print Enquiry List].

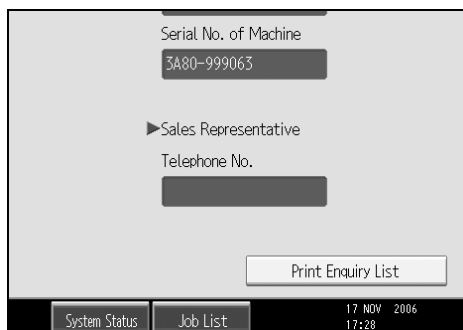

3 Press the **[Start]** key.

Enquiry information prints out.

4 Press **[Exit]** twice.

Counter

Displaying the Total Counter

You can display the total counter value used for all functions.

- 1 Press [Counter].

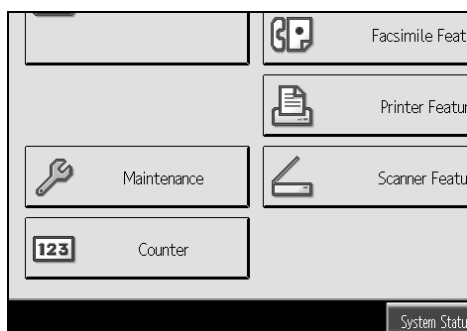

- 2 To print a counter list, press [Print Counter List]. Changing the Display Language

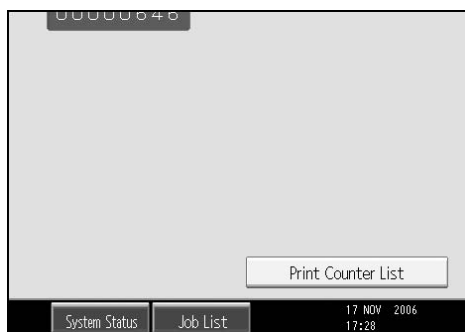

- 3 Press the [Start] key.
A counter list prints out.

Specifications for the Main Unit

- ❖ **Configuration:**
Desktop
- ❖ **Photosensitivity type:**
OPC drum
- ❖ **Original scanning:**
One-dimensional solid scanning system through CCD
- ❖ **Copy process:**
Dry electrostatic transfer system
- ❖ **Development:**
Dry two-component magnetic brush development system
- ❖ **Fusing:**
Oilless belt fusing
- ❖ **Resolution:**
600 dpi
- ❖ **Exposure glass:**
Stationary original exposure type
- ❖ **Original reference position:**
Rear left corner
- ❖ **Warm-up time:**
Type 1,2: 45 seconds or less (23°C)
- ❖ **Originals:**
Sheet/book/objects
- ❖ **Maximum original size:**
A3☐, 11"×17"☐
- ❖ **Copy paper size:**
 - Trays: A3☐-A5☐, 11"×17"☐-7¹/₄"×10¹/₂"☐
 - Bypass: A3☐-A6☐, 11"×17"☐-7¹/₄"×10¹/₂"☐
 - Bypass (custom size): Vertical: 90.0-305.0mm, 3.55"-12.00" Horizontal: 148.0-600.0mm, 5.83"-23.62"
 - Duplex: A3☐-A5☐, 11"×17"☐-10¹/₂"☐
 - LCT: A4☐, 8¹/₂"×11"☐

❖ **Paper weight:**

- Paper Tray: 60-216g/m², 16-57lb.
- Bypass: 60-253g/m², 16-67lb.
- Duplex: 64-169g/m², 17-45lb.

❖ **Non-reproduction area:**

- Leading edge: 4.5±1.5mm, 0.18"-0.06"
- Trailing edge: 0.5-6.0mm, 0"-0.24"
- Left edge: 0.5-4.0mm, 0"-0.16"
- Right edge: 0.5-4.0mm, 0"-0.16"

❖ **First copy time:**

- Type 1, 2:
 - Colour: 9.7 seconds or less
 - B&W: 6.7 seconds or less

❖ **Copying speed: (Type 1) Full Colour / B&W**

- 12/12 copies/minute (A3☐, 11"×17"☐)
- 25/25 copies/minute (A4☐, 8¹/₂"×11"☐)

❖ **Copying speed: (Type 2) Full Colour / B&W**

- 15/15 copies/minute (A3☐, 11"×17"☐)
- 30/30 copies/minute (A4☐, 8¹/₂"×11"☐)

❖ **Reproduction ratio:**

Preset reproduction ratios:

- Enlargement

Metric version	Inch version
400%	400%
200%	200%
141%	155%
122%	129%
115%	121%

- Full size

Metric version	Inch version
100%	100%

- Reduction

Metric version	Inch version
93%	93%
82%	85%
75%	78%
71%	73%
65%	65%
50%	50%
25%	25%

Zoom: From 25 to 400% in increments of 1%

- ❖ **Maximum continuous copy run:**

999 sheets

- ❖ **Paper capacity:**

- Tray1,2: 550 sheets (80g/m², 20lb.)
- Bypass tray: 100 sheets (80g/m², 20lb.)

- ❖ **Power consumption:**

- Main unit only

	Type 1	Type 2
Warm-up	about 1.60 kW	about 1.60 kW
Stand-by	about 0.20 kW	about 0.20 kW
During printing	about 1.10 kW	about 1.10 kW
Maximum	about 1.60 kW	about 1.60 kW

- Complete system

	Type 1	Type 2
Warm-up	about 1.60 kW	about 1.60 kW
Stand-by	about 0.20 kW	about 0.20 kW
During printing	about 1.10 kW	about 1.10 kW
Maximum	about 1.60 kW	about 1.60 kW

The complete system consists of the main unit, booklet finisher, large capacity tray, file format converter, IEEE 802.11b (wireless LAN) interface unit, and USB Host interface unit.

- ❖ **Dimensions (W × D × H up to exposure glass):**

650×659×740mm, 25.6"×26.0"×30.0"

- ❖ **Space for main unit (W × D):**

Type 1,2: 855×659mm, 33.7"×26.0"

❖ **Noise emission:**

Sound power level:

- Main unit only

	Type 1	Type 2
Stand-by	less than 40 dB(A)	less than 40 dB(A)
Copying	less than 65 dB(A)	less than 65 dB(A)

- Complete system

	Type 1	Type 2
Stand-by	less than 40 dB(A)	less than 40 dB(A)
Copying	less than 70 dB(A)	less than 70 dB(A)

Sound pressure level:

- Main unit only

	Type 1	Type 2
Stand-by	less than 26 dB(A)	less than 26 dB(A)
Copying	less than 51 dB(A)	less than 51 dB(A)

- Complete system

	Type 1	Type 2
Stand-by	less than 26 dB(A)	less than 26 dB(A)
Copying	less than 59 dB(A)	less than 60 dB(A)

- Sound power level and sound pressure level are actual values measured in accordance with ISO 7779.
- Sound power level and sound pressure level are measured from the position of the bystander.
- The complete system consists of the main unit, auto document feeder, 2 tray paper unit, bridge unit, booklet finisher, and punch kit for the booklet finisher.

❖ **Weight:**

Type 1, 2: Approx. 105 kg, 231.5lb.

❖ **HDD:**

40 GB or more

- Capacity for Document Server
16.8 GB
- Capacity for memory sorting
3.4-8.7 GB
- Capacity for others
8.7 GB or more





Auto Document Feeder

Lower this over originals for copying.

❖ **Mode:**

ADF mode, Batch mode, SADF mode, Mixed Size mode, Custom Size Originals mode, Auto detect (A4, 8¹/₂"×11")

❖ **Original size:**

A3 -A5  11"×17" -5¹/₂"×8¹/₂"   Vertical: 128-297mm, 5.1"-11.7"
Horizontal: 128-1260mm, 5.1"-49.6"

❖ **Maximum number of originals:**

50 sheets (80g/m², 20lb.)

❖ **Dimensions (W×D×H):**

550×491×120mm, 21.7"×19.4"×49.7"

❖ **Weight:**

Approx. 10kg, 22.1lb.

Specifications for Options

❖ Exposure Glass Cover

Lower this over originals for copying.

❖ 500-sheet Finisher

- Paper size:
A3, B4JIS, A4, B5JIS, A5, 11"×17", 8¹/₂"×14", 8¹/₂"×11", 5¹/₂"×8¹/₂"
- Paper weight:
52-128g/m², 14-34lb.
- Stack capacity:
 - 500 sheets: A4, B5JIS, A5, 8¹/₂"×11", 5¹/₂"×8¹/₂"
 - 250 sheets: A3, B4JIS, 11"×17", 8¹/₂"×14"
- Staple paper size:
A3, B4JIS, A4, B5JIS, 11"×17", 8¹/₂"×14", 8¹/₂"×11"
- Staple capacity:
 - 30 sheets: A3, B4JIS, 11"×17", 8¹/₂"×14" (80g/m², 20lb.)
 - 50 sheets: A4, B5JIS, 8¹/₂"×11" (80g/m², 20lb.)
- Staple paper weight:
64-90g/m², 17-24lb.
- Staple position:
 - 1 staple - 2 positions
 - 2 staples - 2 positions
- Power consumption:
50W or less (power is supplied from the main unit)
- Dimensions (W×D×H):
411×521×261mm, 16.2"×20.6"×10.3"
- Weight:
Approx. 12kg, 26.5lb.

❖ 1000-sheet Finisher

Finisher Upper Tray:

- Paper size:
A3, B4JIS, A4, B5JIS, A5, B6JIS, A6, 11"×17", 8¹/₂"×14", 8¹/₂"×13", 8¹/₂"×11", 8¹/₄"×14", 8¹/₄"×13", 8"×13", 5¹/₂"×8¹/₂", 7¹/₄"×10¹/₂"
- Paper weight:
52-260g/m², 14-69lb.
- Stack capacity:
 - 250 sheets: A4, 8¹/₂"×11" or smaller (80g/m², 20lb.)
 - 50 sheets: B4JIS, 8¹/₂"×14" or larger (80g/m², 20lb.)

Finisher Shift Tray:

- Paper size:
A3, B4JIS, A4, B5JIS, A5, 11"×17", 8¹/₂"×14", 8¹/₂"×13", 8¹/₂"×11", 8¹/₄"×14", 8¹/₄"×13", 8"×13", 5¹/₂"×8¹/₂", 7¹/₄"×10¹/₂"
- Paper weight:
52-163g/m², 14-43lb.
- Stack capacity:
No Staple:
 - 1,000 sheets: A4 or smaller (80g/m², 20lb.)
 - 500 sheets: B4JIS or larger (80g/m², 20lb)
 Staple:
 - 2-9 sheets: 100 sets (A4, 8¹/₂"×11") (80g/m², 20lb.)
 - 10-50 sheets: 100–20 sets (A4, 8¹/₂"×11") (80g/m², 20lb.)
 - 2-9 sheets: 100 sets (A4, B5JIS, 8¹/₂"×11") (80g/m², 20lb.)
 - 10-50 sheets: 50–10 sets (A4, B5JIS, 8¹/₂"×11") (80g/m², 20lb.)
 - 2-9 sheets: 50 sets (A3, B4JIS, 11"×17", 8¹/₂"×14") (80g/m², 20lb.)
 - 10-30 sheets: 50-10 sets (A3, B4JIS, 11"×17", 8¹/₂"×14") (80g/m², 20lb.)
- Staple capacity:
 - 30 sheets: B4JIS or larger (80g/m², 20lb)
 - 50 sheets: A4 or smaller (80g/m², 20lb.)
- Staple paper size: A3, B4JIS, A4, B5JIS, 11"×17", 8¹/₂"×14", 8¹/₂"×13", 8¹/₂"×11", 8¹/₄"×14", 8¹/₄"×13", 8"×13", 7¹/₄"×10¹/₂"
- Staple paper weight:
64-90g/m², 17-28lb.
- Staple position:
 - 1 staple - 2 positions
 - 2 staples - 1 position
- Power consumption:
Approx. 50W (power supplied from main unit)
- Dimensions (W×D×H):
520×520×790mm, 20.5"×20.5"×31.2"
- Weight:
Approx. 25kg, 55.1lb.

❖ **Booklet Finisher****Finisher Upper Tray:**

- Paper size:
A3☐☐, B4JIS☐☐, A4☐☐, B5JIS☐☐, A5☐☐, A6☐☐, B6JIS☐☐, 11"×17"☐☐,
8¹/₂"×14"☐☐, 8¹/₂"×11"☐☐, 8¹/₂"×5¹/₂"☐☐
- Paper weight:
52-105g/m², 14-28lb.
- Stack capacity:
 - 100 sheets: A4☐☐, B5JIS☐☐, A5☐☐, A6☐☐, B6JIS☐☐, 11"×17"☐☐,
8¹/₂"×11"☐☐, 8¹/₂"×5¹/₂"☐☐
 - 50 sheets: A3☐☐, B4JIS☐☐, 11"×17"☐☐, 8¹/₂"×14"☐☐

Finisher Shift Tray:

- Paper size:
A3☐☐, B4JIS☐☐, A4☐☐, B5JIS☐☐, A5☐☐, A6☐☐, B6JIS☐☐, 11"×17"☐☐,
8¹/₂"×14"☐☐, 8¹/₂"×11"☐☐, 8¹/₂"×5¹/₂"☐☐
- Paper weight:
52-250g/m², 14–66.5lb.
- Stack capacity:
No Staple:
 - 1,000 sheets: A4☐☐, B5JIS☐☐, A5☐☐, 8¹/₂"×11"☐☐ (80g/m²,
20lb.)
 - 500 sheets: A3☐☐, B4JIS☐☐, 8¹/₂"×14"☐☐, 11"×17"☐☐ (80g/m², 20lb.)
 Staple:
 - 2-9 sheets: 100 sets (A4☐☐, B5JIS☐☐, 8¹/₂"×11"☐☐) (80g/m², 20lb.)
 - 10-50 sheets: 100–20 sets (A4☐☐, B5JIS☐☐, 8¹/₂"×11"☐☐) (80g/m²,
20lb.)
 - 2-9 sheets: 50 sets (A3☐☐, B4JIS☐☐, 8¹/₂"×14"☐☐, 11"×17"☐☐) (80g/m²,
20lb.)
 - 10–30 sheets: 50–10 sets (A3☐☐, B4JIS☐☐, 8¹/₂"×14"☐☐, 11"×17"☐☐)
(80g/m², 20lb.)
- Staple capacity:
 - 2-30 sheets: A3☐☐ B4JIS☐☐, 8¹/₂"×14"☐☐, 11"×17"☐☐ (80g/m², 20lb.)
 - 2-50 sheets: A4☐☐, B5JIS☐☐, A5JIS☐☐, 8¹/₂"×11"☐☐ (80g/m²,
20lb.)
- Staple paper size:
A3☐☐, B4JIS☐☐, A4☐☐, B5JIS☐☐, A5☐☐, 11"×17"☐☐, 8¹/₂"×14"☐☐,
8¹/₂"×11"☐☐
- Staple paper weight:
60-90g/m², 17-24lb.
- Staple position
 - 1 staples - 2 positions
 - 2 staples - 2 positions

- Saddle stitch
 - Paper size:
A3☐, B4JIS☐, A4☐, B5JIS☐, 11"×17"☐, 8½"×14"☐, 8½"×11"☐
 - Saddle stitching capacity:
2-10 sheets
 - Stack capacity:
2-5 sheets: 20 sets
6-10 sheets: 10 sets
 - Folding:
Center folding
 - Paper weight:
64-90g/m², 17-24lb.
 - Position:
1 position
- Power consumption:
60W (power is supplied from the main unit)
- Dimensions (W×D×H)
535×600×930mm, 21"×23.7"×36.7"
- Weight:
Approx. 48kg, 105.9lb.



❖ Punch Kit (Booklet Finisher)

- Paper size:
A3☐, B4JIS☐, A4☐☐, B5JIS☐☐, A5☐, 11"×17"☐, 8½"×14"☐, 8½"×11"☐☐
- Paper weight:
52-163g/m², 14-43.4lb.

❖ 2 Tray Paper Unit

- Paper size:
A3☐, B4JIS☐, A4☐☐, B5JIS☐☐, A5☐, 11"×17"☐, 8½"×14"☐, 8½"×11"☐☐, 8¼"×14"☐, 7¼"×10½"☐☐, 8"×13"☐, 8½"×13"☐, 8¼"×13"☐, 8K☐, 16K☐☐
- Paper weight:
60-216g/m², 16-57lb.
- Paper capacity:
1,100 sheets (80g/m², 20lb.) ×2 trays
- Power consumption:
Maximum 50W (power is supplied from the main unit)
- Dimensions (W×D×H):
580×620×260mm, 22.9"×24.5"×10.3"
- Weight:
Approx. 25kg 55.2lb.

❖ Large Capacity Tray

- Paper size:
A4 , 8¹/₂"×11" 
- Paper weight:
60-105g/m², 16-28lb.
- Paper capacity:
2,000 sheets (80g/m², 20lb.)
- Power consumption:
Maximum 50W (power is supplied from the main unit)
- Dimensions (W×D×H, option unit):
580×620×260mm, 22.9"×24.5"×10.3"
- Weight:
Approx. 25kg, 55.2lb.

❖ Bridge Unit

- Dimensions:
415×412×111mm, 16.4"×16.3"×4.4"
- Weight:
Approx. 5kg, 11lb.

Information about Installed Software

expat

- The software including controller, etc. (hereinafter "software") installed on this product uses the expat under the conditions mentioned below.
- The product manufacturer provides warranty and support to the software of the product including the expat, and the product manufacturer makes the initial developer and copyright holder of the expat, free from these obligations.
- Information relating to the expat is available at:
<http://expat.sourceforge.net/>

Copyright (c) 1998, 1999, 2000 Thai Open Source Software Centre, Ltd. and Clark Cooper.

Copyright © 2001, 2002 Expat maintainers.

Permission is hereby granted, free of charge, to any person obtaining a copy of this software and associated documentation files (the "Software"), to deal in the Software without restriction, including without limitation the rights to use, copy, modify, merge, publish, distribute, sublicense, and/or sell copies of the Software, and to permit persons to whom the Software is furnished to do so, subject to the following conditions:

The above copyright notice and this permission notice shall be included in all copies or substantial portions of the Software.

THE SOFTWARE IS PROVIDED "AS IS", WITHOUT WARRANTY OF ANY KIND, EXPRESS OR IMPLIED, INCLUDING BUT NOT LIMITED TO THE WARRANTIES OF MERCHANTABILITY, FITNESS FOR A PARTICULAR PURPOSE AND NONINFRINGEMENT. IN NO EVENT SHALL THE AUTHORS OR COPYRIGHT HOLDERS BE LIABLE FOR ANY CLAIM, DAMAGES OR OTHER LIABILITY, WHETHER IN AN ACTION OF CONTRACT, TORT OR OTHERWISE, ARISING FROM, OUT OF OR IN CONNECTION WITH THE SOFTWARE OR THE USE OR OTHER DEALINGS IN THE SOFTWARE.

NetBSD

1. Copyright Notice of NetBSD

For all users to use this product:

This product contains NetBSD operating system:

For the most part, the software constituting the NetBSD operating system is not in the public domain; its authors retain their copyright.

The following text shows the copyright notice used for many of the NetBSD source code. For exact copyright notice applicable for each of the files/binaries, the source code tree must be consulted.

A full source code can be found at <http://www.netbsd.org/>.

Copyright © 1999, 2000 The NetBSD Foundation, Inc.

All rights reserved.

Redistribution and use in source and binary forms, with or without modification, are permitted provided that the following conditions are met:

- ① Redistributions of source code must retain the above copyright notice, this list of conditions and the following disclaimer.
- ② Redistributions in binary form must reproduce the above copyright notice, this list of conditions and the following disclaimer in the documentation and/or other materials provided with the distribution.
- ③ All advertising materials mentioning features or use of this software must display the following acknowledgment:
This product includes software developed by The NetBSD Foundation, Inc. and its contributors.
- ④ Neither the name of The NetBSD Foundation nor the names of its contributors may be used to endorse or promote products derived from this software without specific prior written permission.

THIS SOFTWARE IS PROVIDED BY THE NETBSD FOUNDATION, INC. AND CONTRIBUTORS "AS IS" AND ANY EXPRESS OR IMPLIED WARRANTIES, INCLUDING, BUT NOT LIMITED TO, THE IMPLIED WARRANTIES OF MERCHANTABILITY AND FITNESS FOR A PARTICULAR PURPOSE ARE DISCLAIMED. IN NO EVENT SHALL THE FOUNDATION OR CONTRIBUTORS BE LIABLE FOR ANY DIRECT, INDIRECT, INCIDENTAL, SPECIAL, EXEMPLARY, OR CONSEQUENTIAL DAMAGES (INCLUDING, BUT NOT LIMITED TO, PROCUREMENT OF SUBSTITUTE GOODS OR SERVICES; LOSS OF USE, DATA, OR PROFITS; OR BUSINESS INTERRUPTION) HOWEVER CAUSED AND ON ANY THEORY OF LIABILITY, WHETHER IN CONTRACT, STRICT LIABILITY, OR TORT (INCLUDING NEGLIGENCE OR OTHERWISE) ARISING IN ANY WAY OUT OF THE USE OF THIS SOFTWARE, EVEN IF ADVISED OF THE POSSIBILITY OF SUCH DAMAGE.

2. Authors Name List

All product names mentioned herein are trademarks of their respective owners. The following notices are required to satisfy the license terms of the software that we have mentioned in this document:

- This product includes software developed by the University of California, Berkeley and its contributors.
- This product includes software developed by Jonathan R. Stone for the NetBSD Project.
- This product includes software developed by the NetBSD Foundation, Inc. and its contributors.
- This product includes software developed by Manuel Bouyer.
- This product includes software developed by Charles Hannum.
- This product includes software developed by Charles M. Hannum.
- This product includes software developed by Christopher G. Demetriou.
- This product includes software developed by TooLs GmbH.
- This product includes software developed by Terrence R. Lambert.
- This product includes software developed by Adam Glass and Charles Hannum.
- This product includes software developed by Theo de Raadt.
- This product includes software developed by Jonathan Stone and Jason R. Thorpe for the NetBSD Project.
- This product includes software developed by the University of California, Lawrence Berkeley Laboratory and its contributors.
- This product includes software developed by Christos Zoulas.
- This product includes software developed by Christopher G. Demetriou for the NetBSD Project.
- This product includes software developed by Paul Kranenburg.
- This product includes software developed by Adam Glass.
- This product includes software developed by Jonathan Stone.
- This product includes software developed by Jonathan Stone for the NetBSD Project.
- This product includes software developed by Winning Strategies, Inc.
- This product includes software developed by Frank van der Linden for the NetBSD Project.
- This product includes software developed for the NetBSD Project by Frank van der Linden
- This product includes software developed for the NetBSD Project by Jason R. Thorpe.
- The software was developed by the University of California, Berkeley.
- This product includes software developed by Chris Provenzano, the University of California, Berkeley, and contributors.

Sablotron

Sablotron (Version 0.82) Copyright © 2000 Ginger Alliance Ltd. All Rights Reserved

- a) The application software installed on this product includes the Sablotron software Version 0.82 (hereinafter, "Sablotron 0.82"), with modifications made by the product manufacturer. The original code of the Sablotron 0.82 is provided by Ginger Alliance Ltd., the initial developer, and the modified code of the Sablotron 0.82 has been derived from such original code provided by Ginger Alliance Ltd.
- b) The product manufacturer provides warranty and support to the application software of this product including the Sablotron 0.82 as modified, and the product manufacturer makes Ginger Alliance Ltd., the initial developer of the Sablotron 0.82, free from these obligations.
- c) The Sablotron 0.82 and the modifications thereof are made available under the terms of Mozilla Public License Version 1.1 (hereinafter, "MPL 1.1"), and the application software of this product constitutes the "Larger Work" as defined in MPL 1.1. The application software of this product except for the Sablotron 0.82 as modified is licensed by the product manufacturer under separate agreement(s).
- d) The source code of the modified code of the Sablotron 0.82 is available at: <http://support-download.com/services/device/sablot/notice082.html>
- e) The source code of the Sablotron software is available at: <http://www.ginger-all.com>
- f) MPL 1.1 is available at: <http://www.mozilla.org/MPL/MPL-1.1.html>

JPEG LIBRARY

- The software installed on this product is based in part on the work of the Independent JPEG Group.

SASL

CMU libsasl

Tim Martin

Rob Earhart

Rob Siemborski

Copyright (c) 2001 Carnegie Mellon University. All rights reserved.

Redistribution and use in source and binary forms, with or without modification, are permitted provided that the following conditions are met:

- ① Redistributions of source code must retain the above copyright notice, this list of conditions and the following disclaimer.
- ② Redistributions in binary form must reproduce the above copyright notice, this list of conditions and the following disclaimer in the documentation and/or other materials provided with the distribution.
- ③ The name "Carnegie Mellon University" must not be used to endorse or promote products derived from this software without prior written permission. For permission or any other legal details, please contact:

Office of Technology Transfer
Carnegie Mellon University
5000 Forbes Avenue
Pittsburgh, PA 15213-3890
(412) 268-4387, fax: (412) 268-7395
tech-transfer@andrew.cmu.edu

- ④ Redistributions of any form whatsoever must retain the following acknowledgment:
"This product includes software developed by Computing Services at Carnegie Mellon University (<http://www.cmu.edu/computing/>)."

CARNEGIE MELLON UNIVERSITY DISCLAIMS ALL WARRANTIES WITH REGARD TO THIS SOFTWARE, INCLUDING ALL IMPLIED WARRANTIES OF MERCHANTABILITY AND FITNESS, IN NO EVENT SHALL CARNEGIE MELLON UNIVERSITY BE LIABLE FOR ANY SPECIAL, INDIRECT OR CONSEQUENTIAL DAMAGES OR ANY DAMAGES WHATSOEVER RESULTING FROM LOSS OF USE, DATA OR PROFITS, WHETHER IN AN ACTION OF CONTRACT, NEGLIGENCE OR OTHER TORTIOUS ACTION, ARISING OUT OF OR IN CONNECTION WITH THE USE OR PERFORMANCE OF THIS SOFTWARE.

MD4

Copyright (C) 1990-2, RSA Data Security, Inc. All rights reserved.

License to copy and use this software is granted provided that it is identified as the "RSA Data Security, Inc. MD4 Message-Digest Algorithm" in all material mentioning or referencing this software or this function.

License is also granted to make and use derivative works provided that such works are identified as "derived from the RSA Data Security, Inc. MD4 Message-Digest Algorithm" in all material mentioning or referencing the derived work.

RSA Data Security, Inc. makes no representations concerning either the merchantability of this software or the suitability of this software for any particular purpose. It is provided "as is" without express or implied warranty of any kind.

These notices must be retained in any copies of any part of this documentation and/or software.

MD5

Copyright (C) 1991-2, RSA Data Security, Inc. Created 1991. All rights reserved.

License to copy and use this software is granted provided that it is identified as the "RSA Data Security, Inc. MD5 Message-Digest Algorithm" in all material mentioning or referencing this software or this function.

License is also granted to make and use derivative works provided that such works are identified as "derived from the RSA Data Security, Inc. MD5 Message-Digest Algorithm" in all material mentioning or referencing the derived work.

RSA Data Security, Inc. makes no representations concerning either the merchantability of this software or the suitability of this software for any particular purpose. It is provided "as is" without express or implied warranty of any kind.

These notices must be retained in any copies of any part of this documentation and/or software.

Samba(Ver 3.0.4)

For SMB transmission, this machine uses Samba ver 3.0.4 (hereinafter referred to as Samba 3.0.4).

Copyright © Andrew Tridgell 1994-1998

This program is free software; you can redistribute it and/or modify it under the terms of the GNU General Public License as published by the Free Software Foundation; either version 2 of the License, or (at your option) any later version.

This program is distributed in the hope that it will be useful, but WITHOUT ANY WARRANTY; without even the implied warranty of MERCHANTABILITY or FITNESS FOR A PARTICULAR PURPOSE. See the GNU General Public License along with this program; if not, write to the Free Software Foundation, Inc., 675 Mass Ave, Cambridge, MA 02139, USA.

 **Note**

- The source code for SMB transmission by this machine can be downloaded from the following website:

<http://support-download.com/services/scbs>

RSA BSAFE®



- This product includes RSA BSAFE® cryptographic or security protocol software from RSA Security Inc.
- RSA and BSAFE are registered trademarks of RSA Security Inc. in the United States and/or other countries.
- RSA Security Inc. All rights reserved.

Open SSL

Copyright (c) 1998-2004 The OpenSSL Project. All rights reserved.

Redistribution and use in source and binary forms, with or without modification, are permitted provided that the following conditions are met:

1. Redistributions of source code must retain the above copyright notice, this list of conditions and the following disclaimer.
2. Redistributions in binary form must reproduce the above copyright notice, this list of conditions and the following disclaimer in the documentation and/or other materials provided with the distribution.
3. All advertising materials mentioning features or use of this software must display the following acknowledgment: "This product includes software developed by the OpenSSL Project for use in the OpenSSL Toolkit. (<http://www.openssl.org/>)"
4. The names "OpenSSL Toolkit" and "OpenSSL Project" must not be used to endorse or promote products derived from this software without prior written permission. For written permission, please contact openssl-core@openssl.org.
5. Products derived from this software may not be called "OpenSSL" nor may "OpenSSL" appear in their names without prior written permission of the OpenSSL Project.
6. Redistributions of any form whatsoever must retain the following acknowledgment: "This product includes software developed by the OpenSSL Project for use in the OpenSSL Toolkit (<http://www.openssl.org/>)"

THIS SOFTWARE IS PROVIDED BY THE OpenSSL PROJECT ``AS IS" AND ANY EXPRESSED OR IMPLIED WARRANTIES, INCLUDING, BUT NOT LIMITED TO, THE IMPLIED WARRANTIES OF MERCHANTABILITY AND FITNESS FOR A PARTICULAR PURPOSE ARE DISCLAIMED. IN NO EVENT SHALL THE OpenSSL PROJECT OR ITS CONTRIBUTORS BE LIABLE FOR ANY DIRECT, INDIRECT, INCIDENTAL, SPECIAL, EXEMPLARY, OR CONSEQUENTIAL DAMAGES (INCLUDING, BUT NOT LIMITED TO, PROCUREMENT OF SUBSTITUTE GOODS OR SERVICES; LOSS OF USE, DATA, OR PROFITS; OR BUSINESS INTERRUPTION) HOWEVER CAUSED AND ON ANY THEORY OF LIABILITY, WHETHER IN CONTRACT, STRICT LIABILITY, OR TORT (INCLUDING NEGLIGENCE OR OTHERWISE) ARISING IN ANY WAY OUT OF THE USE OF THIS SOFTWARE, EVEN IF ADVISED OF THE POSSIBILITY OF SUCH DAMAGE.

This product includes cryptographic software written by Eric Young (eay@cryptsoft.com). This product includes software written by Tim Hudson (tjh@cryptsoft.com).

Original SSLeay License

Copyright (C) 1995-1998 Eric Young (eay@cryptsoft.com) All rights reserved.

This package is an SSL implementation written by Eric Young (eay@cryptsoft.com).

The implementation was written so as to conform with Netscapes SSL.

This library is free for commercial and non-commercial use as long as the following conditions are aheared to. The following conditions apply to all code found in this distribution, be it the RC4, RSA, lhash, DES, etc., code; not just the SSL code. The SSL documentation included with this distribution is covered by the same copyright terms except that the holder is Tim Hudson (tjh@cryptsoft.com).

Note that any information and cryptographic algorithms used in this software are publicly available on the Internet and at any major bookstore, scientific library, and patent office worldwide. More information can be found e.g. at "<http://www.cs.hut.fi/crypto>".

The legal status of this program is some combination of all these permissions and restrictions. Use only at your own responsibility. You will be responsible for any legal consequences yourself; I am not making any claims whether possessing or using this is legal or not in your country, and I am not taking any responsibility on your behalf.

NO WARRANTY

BECAUSE THE PROGRAM IS LICENSED FREE OF CHARGE, THERE IS NO WARRANTY FOR THE PROGRAM, TO THE EXTENT PERMITTED BY APPLICABLE LAW. EXCEPT WHEN OTHERWISE STATED IN WRITING THE COPYRIGHT HOLDERS AND/OR OTHER PARTIES PROVIDE THE PROGRAM "AS IS" WITHOUT WARRANTY OF ANY KIND, EITHER EXPRESSED OR IMPLIED, INCLUDING, BUT NOT LIMITED TO, THE IMPLIED WARRANTIES OF MERCHANTABILITY AND FITNESS FOR A PARTICULAR PURPOSE. THE ENTIRE RISK AS TO THE QUALITY AND PERFORMANCE OF THE PROGRAM IS WITH YOU. SHOULD THE PROGRAM PROVE DEFECTIVE, YOU ASSUME THE COST OF ALL NECESSARY SERVICING, REPAIR OR CORRECTION.

IN NO EVENT UNLESS REQUIRED BY APPLICABLE LAW OR AGREED TO IN WRITING WILL ANY COPYRIGHT HOLDER, OR ANY OTHER PARTY WHO MAY MODIFY AND/OR REDISTRIBUTE THE PROGRAM AS PERMITTED ABOVE, BE LIABLE TO YOU FOR DAMAGES, INCLUDING ANY GENERAL, SPECIAL, INCIDENTAL OR CONSEQUENTIAL DAMAGES ARISING OUT OF THE USE OR INABILITY TO USE THE PROGRAM (INCLUDING BUT NOT LIMITED TO LOSS OF DATA OR DATA BEING RENDERED INACCURATE OR LOSSES SUSTAINED BY YOU OR THIRD PARTIES OR A FAILURE OF THE PROGRAM TO OPERATE WITH ANY OTHER PROGRAMS), EVEN IF SUCH HOLDER OR OTHER PARTY HAS BEEN ADVISED OF THE POSSIBILITY OF SUCH DAMAGES.

2)

The 32-bit CRC compensation attack detector in deattack.c was contributed by CORE SDI S.A. under a BSD-style license.

Cryptographic attack detector for ssh - source code

Copyright (c) 1998 CORE SDI S.A., Buenos Aires, Argentina.

All rights reserved. Redistribution and use in source and binary forms, with or without modification, are permitted provided that this copyright notice is retained.

THIS SOFTWARE IS PROVIDED "AS IS" AND ANY EXPRESS OR IMPLIED WARRANTIES ARE DISCLAIMED. IN NO EVENT SHALL CORE SDI S.A. BE LIABLE FOR ANY DIRECT, INDIRECT, INCIDENTAL, SPECIAL, EXEMPLARY OR CONSEQUENTIAL DAMAGES RESULTING FROM THE USE OR MISUSE OF THIS SOFTWARE.

Ariel Futoransky <futo@core-sdi.com>

<<http://www.core-sdi.com>>

3)

One component of the ssh source code is under a 3-clause BSD license, held by the University of California, since we pulled these parts from original Berkeley code.

Copyright (c) 1983, 1990, 1992, 1993, 1995

The Regents of the University of California. All rights reserved.

Redistribution and use in source and binary forms, with or without modification, are permitted provided that the following conditions are met:

1. Redistributions of source code must retain the above copyright notice, this list of conditions and the following disclaimer.

2. Redistributions in binary form must reproduce the above copyright notice, this list of conditions and the following disclaimer in the documentation and/or other materials provided with the distribution.

3. Neither the name of the University nor the names of its contributors may be used to endorse or promote products derived from this software without specific prior written permission.

THIS SOFTWARE IS PROVIDED BY THE REGENTS AND CONTRIBUTORS ``AS IS'' AND ANY EXPRESS OR IMPLIED WARRANTIES, INCLUDING, BUT NOT LIMITED TO, THE IMPLIED WARRANTIES OF MERCHANTABILITY AND FITNESS FOR A PARTICULAR PURPOSE ARE DISCLAIMED. IN NO EVENT SHALL THE REGENTS OR CONTRIBUTORS BE LIABLE FOR ANY DIRECT, INDIRECT, INCIDENTAL, SPECIAL, EXEMPLARY, OR CONSEQUENTIAL DAMAGES (INCLUDING, BUT NOT LIMITED TO, PROCUREMENT OF SUBSTITUTE GOODS OR SERVICES; LOSS OF USE, DATA, OR PROFITS; OR BUSINESS INTERRUPTION) HOWEVER CAUSED AND ON ANY THEORY OF LIABILITY, WHETHER IN CONTRACT, STRICT LIABILITY, OR TORT (INCLUDING NEGLIGENCE OR OTHERWISE) ARISING IN ANY WAY OUT OF THE USE OF THIS SOFTWARE, EVEN IF ADVISED OF THE POSSIBILITY OF SUCH DAMAGE.

4)

Remaining components of the software are provided under a standard 2-term BSD licence with the following names as copyright holders:

Markus Friedl

Theo de Raadt

Niels Provos

Dug Song

Kevin Steves

Daniel Kouril

Wesley Griffin

Per Allansson

Jason Downs

Solar Designer

Todd C. Miller

Redistribution and use in source and binary forms, with or without modification, are permitted provided that the following conditions are met:

1. Redistributions of source code must retain the above copyright notice, this list of conditions and the following disclaimer.

2. Redistributions in binary form must reproduce the above copyright notice, this list of conditions and the following disclaimer in the documentation and/or other materials provided with the distribution.

THIS SOFTWARE IS PROVIDED BY THE AUTHOR "AS IS" AND ANY EXPRESS OR IMPLIED WARRANTIES, INCLUDING, BUT NOT LIMITED TO, THE IMPLIED WARRANTIES OF MERCHANTABILITY AND FITNESS FOR A PARTICULAR PURPOSE ARE DISCLAIMED. IN NO EVENT SHALL THE AUTHOR BE LIABLE FOR ANY DIRECT, INDIRECT, INCIDENTAL, SPECIAL, EXEMPLARY, OR CONSEQUENTIAL DAMAGES (INCLUDING, BUT NOT LIMITED TO, PROCUREMENT OF SUBSTITUTE GOODS OR SERVICES; LOSS OF USE, DATA, OR PROFITS; OR BUSINESS INTERRUPTION) HOWEVER CAUSED AND ON ANY THEORY OF LIABILITY, WHETHER IN CONTRACT, STRICT LIABILITY, OR TORT (INCLUDING NEGLIGENCE OR OTHERWISE) ARISING IN ANY WAY OUT OF THE USE OF THIS SOFTWARE, EVEN IF ADVISED OF THE POSSIBILITY OF SUCH DAMAGE.

5)

Portable OpenSSH contains the following additional licenses:

c) Compatibility code (openbsd-compat)

Apart from the previously mentioned licenses, various pieces of code in the openbsd-compat/ subdirectory are licensed as follows:

Some code is licensed under a 3-term BSD license, to the following copyright holders:

Todd C. Miller

Theo de Raadt

Damien Miller

Eric P. Allman

The Regents of the University of California

Redistribution and use in source and binary forms, with or without modification, are permitted provided that the following conditions are met:

1. Redistributions of source code must retain the above copyright notice, this list of conditions and the following disclaimer.
2. Redistributions in binary form must reproduce the above copyright notice, this list of conditions and the following disclaimer in the documentation and/or other materials provided with the distribution.
3. Neither the name of the University nor the names of its contributors may be used to endorse or promote products derived from this software without specific prior written permission.

THIS SOFTWARE IS PROVIDED BY THE REGENTS AND CONTRIBUTORS ``AS IS" AND ANY EXPRESS OR IMPLIED WARRANTIES, INCLUDING, BUT NOT LIMITED TO, THE IMPLIED WARRANTIES OF MERCHANTABILITY AND FITNESS FOR A PARTICULAR PURPOSE ARE DISCLAIMED. IN NO EVENT SHALL THE REGENTS OR CONTRIBUTORS BE LIABLE FOR ANY DIRECT, INDIRECT, INCIDENTAL, SPECIAL, EXEMPLARY, OR CONSEQUENTIAL DAMAGES (INCLUDING, BUT NOT LIMITED TO, PROCUREMENT OF SUBSTITUTE GOODS OR SERVICES; LOSS OF USE, DATA, OR PROFITS; OR BUSINESS INTERRUPTION) HOWEVER CAUSED AND ON ANY THEORY OF LIABILITY, WHETHER IN CONTRACT, STRICT LIABILITY, OR TORT (INCLUDING NEGLIGENCE OR OTHERWISE) ARISING IN ANY WAY OUT OF THE USE OF THIS SOFTWARE, EVEN IF ADVISED OF THE POSSIBILITY OF SUCH DAMAGE.

Open LDAP

The OpenLDAP Public License Version 2.8, 17 August 2003

Redistribution and use of this software and associated documentation ("Software"), with or without modification, are permitted provided that the following conditions are met:

1. Redistributions in source form must retain copyright statements and notices,
2. Redistributions in binary form must reproduce applicable copyright statements and notices, this list of conditions, and the following disclaimer in the documentation and/or other materials provided with the distribution, and
3. Redistributions must contain a verbatim copy of this document.

The OpenLDAP Foundation may revise this license from time to time. Each revision is distinguished by a version number. You may use this Software under terms of this license revision or under the terms of any subsequent revision of the license.

THIS SOFTWARE IS PROVIDED BY THE OPENLDAP FOUNDATION AND ITS CONTRIBUTORS ``AS IS" AND ANY EXPRESSED OR IMPLIED WARRANTIES, INCLUDING, BUT NOT LIMITED TO, THE IMPLIED WARRANTIES OF MERCHANTABILITY AND FITNESS FOR A PARTICULAR PURPOSE ARE DISCLAIMED. IN NO EVENT SHALL THE OPENLDAP FOUNDATION, ITS CONTRIBUTORS, OR THE AUTHOR(S) OR OWNER(S) OF THE SOFTWARE BE LIABLE FOR ANY DIRECT, INDIRECT, INCIDENTAL, SPECIAL, EXEMPLARY, OR CONSEQUENTIAL DAMAGES (INCLUDING, BUT NOT LIMITED TO, PROCUREMENT OF SUBSTITUTE GOODS OR SERVICES; LOSS OF USE, DATA, OR PROFITS; OR BUSINESS INTERRUPTION) HOWEVER CAUSED AND ON ANY THEORY OF LIABILITY, WHETHER IN CONTRACT, STRICT LIABILITY, OR TORT (INCLUDING NEGLIGENCE OR OTHERWISE) ARISING IN ANY WAY OUT OF THE USE OF THIS SOFTWARE, EVEN IF ADVISED OF THE POSSIBILITY OF SUCH DAMAGE.

The names of the authors and copyright holders must not be used in advertising or otherwise to promote the sale, use or other dealing in this Software without specific, written prior permission. Title to copyright in this Software shall at all times remain with copyright holders.

OpenLDAP is a registered trademark of the OpenLDAP Foundation.

Copyright 1999-2003 The OpenLDAP Foundation, Redwood City, California, USA. All Rights Reserved. Permission to copy and distribute verbatim copies of this document is granted.

INDEX

-
- 1 Sided → 2 Sided Auto Margin: TtoB, 101
 - 1 Sided → 2 Sided Auto Margin: TtoT, 101
 - 2 Sided Print, 130
 - 4 Colour Graphic Mode, 186

A

- About Address Book, 203
- Accessing User Tools (System Settings), 3
- A.C.S. Priority, 119
- A.C.S. Sensitivity, 119
- A.C.S. Sensitivity Level, 199
- Address Book: Change Order, 78
- Address Book: Edit Title, 80
- Address Book:
 - Program / Change / Delete Group, 78
- Address Book: Switch Title, 81
- Address Book Management, 77
- Adjust Colour Image / Copier /
 - Document Server Features, 119
- Adjust Sound Volume, 122
- Administrator Authentication Management, 82
- Administrator's E-mail Address, 73
- Administrator Tools / System Settings, 77
- ADS Background (Full Colour), 119
- AOF (Always On), 84
- Append CR to LF, 193
- Authentication Information, 212, 268
- Authorized Reception, 159
- Auto Colour Calibration, 273
- Auto Continue, 187
- Auto Delete File in Document Server, 83
- Auto Delete Stored Print Jobs, 187
- Auto Delete Temporary Print Jobs, 187
- Auto Erase Memory Setting, 84
- Auto Image Density Priority, 91
- Auto Logout Timer, 59
- Auto Off Timer, 58
- Auto Specify Sender Name, 76
- Auto Tray Switching, 93

B

- Background Density of ADS (Full Colour), 200
- Background Numbering, 106
- Back Margin: Left/Right, 100
- Back Margin: Top/Bottom, 101
- Backup File TX Setting, 127
- Back Up / Restore Address Book, 81
- Bidirectional Communication, 64
- Bidirectional SCSI print, 66
- Blank Page Print, 188
- Box Setting, 122
- Box Setting: Print List, 123
- Box Settings, 170
- Bypass Tray Setting Priority, 190

C

- Capture Server IP Address, 70
- Centre Mark, 130
- Change PDF Password, 195
- Changing a Fax Destination, 224
- Changing a FTP Folder Destination, 246
- Changing a Group Name, 263
- Changing an E-mail Destination, 236
- Changing a Registered Name, 210
- Changing a User Code, 214
- Changing Fax Number, 225
- Changing the Display Language, 274
- Changing the registered
 - SMB Folder Destination, 242
- Changing the User Parameters, 157
- Channel, 67
- Checked Mark, 130
- Checking the Wireless LAN Connection, 13
- Clearing the Counter, 220
- Clearing the Number of Prints, 220
- Colour Profile, 194, 195
- Colour Registration, 273
- Colour Sensitivity, 119
- Colour Setting, 194, 195
- Communication Mode, 67
- Communication Page Count, 122
- Compression (Black & White), 201

Compression (Gray Scale / Full Colour), 201
 Configuration Page, 183
 Connecting the Telephone Line, 47
 Connecting to the Ethernet Interface, 8
 Connecting to the IEEE 1284 Interface, 11
 Connecting to the IEEE 1394 Interface, 10
 Connecting to the IEEE 802.11b
 (Wireless LAN) Interface, 12
 Connecting to the Interface, 7
 Connecting to the USB Interface, 9
 Copier/Document Server Auto Reset Timer, 58
 Copier / Document Server Features /
 Adjust Colour Image, 119
 Copier / Document Server Features / Edit, 100
 Copier / Document Server Features /
 General Features, 91
 Copier / Document Server Features /
 Input/Output, 116
 Copier / Document Server Features /
 Reproduction Ratio, 96
 Copier / Document Server Features /
 Stamp, 106
 Copy Count Display, 50
 Copy on Designating Page in Combine, 102
 Copy Order in Combine, 102
 Copy Orientation in Duplex Mode, 93
 Counter, 277
 Courier Font, 193
 Cover Sheet Tray, 56
 Customize: Copier Function Key, 94
 Customize: Document Server Storage key, 95

D

Data Format, 194
 Data Security for Copying, 84
 Date Stamp, 111
 DDNS Configuration, 61
 DDNS Configuration (IEEE 1394), 65
 Default Printer Language, 190
 Default User Name / Password (Send), 74
 Delete All Files in Document Server, 83
 Delete All Logs, 84
 Delete All Stored Print Jobs, 186
 Delete All Temporary Print Jobs, 186
 Delete Scanner Journal, 198
 Deleting a Fax Destination, 227
 Deleting a FTP Folder Destination, 248
 Deleting a Group, 264
 Deleting a Group Within Another Group, 261
 Deleting a NCP Folder Destination, 253

Deleting an E-mail Destination, 237
 Deleting a Registered Name, 211
 Deleting a scan size, 142
 Deleting a Special Sender, 169
 Deleting a User Code, 216
 Deleting Fax Information, 146
 Deleting Information Boxes, 177
 Deleting Personal Boxes, 173
 Deleting Transfer Boxes, 181
 Delivery Option, 70
 Density (Background Numbering), 106
 Destination List Display Priority 1, 197
 Destination List Display Priority 2, 198
 Display/Clear/Print Counter per User, 81
 Displaying Names Registered in a Group, 259
 Displaying the Counter for Each User, 217
 Display Panel, 2
 Display/Print Counter, 81
 Divide & Send E-mail, 202
 DNS Configuration, 61
 Document Server, 120
 Domain Name, 61
 Domain Name (IEEE 1394), 65
 Double Copies Separation Line, 104
 Duplex Back Page Stamping Position
 (Page Numbering), 113

E

Edge to Edge Print, 190
 Edit / Copier / Document Server Features, 100
 Effective Protocol, 61
 E-mail Communication Port, 73
 E-mail Destination, 234
 E-mail Information Language, 202
 E-mail Reception Interval, 74
 E-mail Storage in Server, 74
 Enable H.323, 136
 Enable SIP, 136
 Energy Saver Timer, 58
 Enhanced Authentication Management, 82
 Enquiry, 275
 Erase All Memory, 84
 Erase Border Width, 101
 Erase Centre Width, 101
 Erase Original Shadow in Combine, 101
 Error Log, 183
 Ethernet Speed, 62
 Extend A4 Width, 193
 Extended Security, 82

F

Facsimile Auto Reset Timer, 59
Facsimile Features / General Features, 121
Facsimile Features / Initial Settings, 134
Facsimile Features / Reception Settings, 128
Facsimile Features / Scan Settings, 124
Facsimile Features / Send Settings, 125
Fax Destination, 221, 223
Fax E-mail Account, 76
Fax RX File Transmission, 70
File Transfer / System Settings, 70
Firmware Version, 84
Folder Destination, 238
Folder Transfer Result Report, 132
Font (Date Stamp), 111
Font Number, 192
Font (Page Numbering), 113
Font Pitch, 192
Font Source, 192
Format (Date Stamp), 111
Form Lines, 192
Forwarding, 128, 147, 160
Forwarding Mark, 150
Front Cover Copy in Combine, 102
Front Margin: Left/Right, 100
Front Margin: Top/Bottom, 100
Function Priority, 50
Function Reset Timer, 50

G

General Features / Copier /
Document Server Features, 91
General Features / Facsimile Features, 121
General Settings / Scanner Features, 197
General Settings / System Settings, 49

H

H.323 Settings, 136
Hex Dump, 184
High Compression PDF Level, 201
Host Interface / Printer Features, 191
Host Name, 63
Host Name (IEEE 1394), 65

I

IEEE 1394, 65
IEEE 802.11b, 14, 67
Image Repeat Separation Line, 103
Initial Print Job List, 188
Initial Settings / Facsimile Features, 134

Input/Output / Copier /
Document Server Features, 116
Input Prime, 64
Interface Settings / System Settings, 60
Internet Fax Settings, 135
Interpreting the configuration page, 184
I/O Buffer, 191
I/O Timeout, 191
IPv4 Address (IEEE 1394), 65
IPv4 Gateway Address, 60
IPv4 over 1394, 66
IPv6 Gateway Address, 60
IPv6 Stateless Address
Autoconfiguration, 61

J

Job End Call, 93
Job Separation, 187

K

Key Counter Management, 82
Key Repeat, 52

L

LAN Type, 63
LDAP Authentication, 270
LDAP Search, 84
Letterhead Setting, 116, 190
List / Test Print Lock, 186

M

Machine IPv4 Address, 60
Machine IPv6 Address, 60
Machine Name, 63
Maintenance, 273
Maintenance / Printer Features, 186
Max. Copy Quantity, 93
Max. E-mail Size, 125, 201
Max. Reception E-mail Size, 74
Memory Full Auto Scan Restart, 116
Memory Lock, 161
Memory Lock Reception, 133
Memory Overflow, 187
Memory Usage, 188
Menu List, 183
Multiple Lists, 183

N

NCP Delivery Protocol, 62
Network, 60
Network Security Level, 84
Network Settings, 15
No. of Digits for Single Page Files, 202
Number of Scanner Resends, 76
NW Frame Type, 62

O

On Hook Mode Release Time, 123
Orientation, 192
Orientation: Booklet, Magazine, 102
Original Orientation in Duplex Mode, 92
Original Photo Type Priority, 92
Original Type Display, 92
Original Type Priority, 91
Output: Copier, 51
Output: Document Server, 51
Output: Facsimile, 51
Output: Printer, 52
Output tray settings, 52

P

Page Numbering, 113
Page Numbering in Combine
(Page Numbering), 114
Page Size, 189
Panel Off Timer, 58
Panel Tone, 49
Paper Display, 92
Paper Tray, 131, 161
Paper Tray Priority: Copier, 53
Paper Tray Priority: Facsimile, 53
Paper Tray Priority: Printer, 53
Paper Type: Bypass Tray, 55
Paper Type: Tray 1-4, 55
Parallel Communication Speed, 64
Parallel Interface, 64
Parallel Timing, 64
Parameter Setting, 134
Parameter Setting: Print List, 134
Parameter Settings, 151
PCL Config./Font Page, 183
PCL Menu / Printer Features, 192
PDF Config./Font Page, 184
PDF Group Password, 195
PDF Menu / Printer Features, 195
Permit SNMPv3 Communication, 63

Permit SSL/TLS Communication, 63
Ping Command, 63
Point Size, 192
POP3 / IMAP4 Settings, 73
POP before SMTP, 72
Preset Stamp, 107
Print Address Book: Destination List, 80
Print & Delete Scanner Journal, 198
Printer Auto Reset Timer, 59
Printer Bypass Paper Size, 54
Printer Features / Host Interface, 191
Printer Features / Maintenance, 186
Printer Features / PCL Menu, 192
Printer Features / PDF Menu, 195
Printer Features / PS Menu, 194
Printer Features / System, 187
Printer Features / Test Print, 183
Printer Language, 189
Print Error Report, 187
Printing the Box List, 182
Printing the configuration page, 184
Printing the Counter for All User, 219
Printing the Counter for Each User, 217
Print List, 69
Print Priority, 50
Print Reception Time, 131
Print Scanner Journal, 198
Program / Change Administrator, 82
Program / Change / Delete E-mail Message, 75
Program / Change / Delete Gateway, 137
Program / Change/Delete LDAP Server, 83, 85
Program / Change / Delete Scan Size, 124, 141
Program / Change / Delete
Standard Message, 126
Program / Change / Delete User Text, 49
Program Closed Network Code, 134
Program/Delete Stamp (User Stamp), 110
Program Fax Information, 136
Program Memory Lock ID, 135
Programming an End Receiver, 148
Programming/Changing
Information Boxes, 174
Programming/changing Personal Boxes, 170
Programming/Changing Special Senders, 162
Programming/Changing Transfer Boxes, 178
Programming Initial Set Up of
a Special Sender, 166
Programming the LDAP server, 86
Program Special Sender, 128
PS Config./Font Page, 183
PS Menu / Printer Features, 194

Q

- Quick Operation Key (1-3), 121
- Quitting the forwarding function, 150

R

- Ratio for Create Margin, 99
- Reception File Print Quantity, 131, 160
- Reception File Setting, 128, 139
- Reception Protocol, 72
- Reception Report e-mail, 140
- Reception Settings / Facsimile Features, 128
- Registering a Fax Destination, 223
- Registering a FTP Folder Destination, 244
- Registering a Group, 255
- Registering a NCP Folder Destination, 249
- Registering an E-mail Destination, 234
- Registering an SMB Folder Destination, 238
- Registering a Protection Code
 - to a Group User, 267
- Registering a Protection Code
 - to a Single User, 265
- Registering a User Code, 213
- Registering Fax Information, 143, 144
- Registering Folders, 238
- Registering LDAP Authentication, 268, 270
- Registering Names, 209
- Registering Names to a Group, 256
- Registering SMTP Authentication, 268
- Registering user names
 - and destination names, 209
- Removing a Name from a Group, 260
- Reproduction Ratio, 97
- Reproduction Ratio / Copier /
 - Document Server Features, 96
- R/E Ratio Priority, 98
- Reserved Job Waiting Time, 188
- Resolution, 193, 194, 195
- Restore Factory Defaults, 68
- Rotate Sort: Auto Paper Continue, 116

S

- SADF Auto Reset, 116
- Scanner Auto Reset Timer, 59
- Scanner Features / General Settings, 197
- Scanner Features / Scan Settings, 199
- Scanner Features / Send Settings, 201
- Scanner Resend Interval Time, 76
- Scan Settings / Facsimile Features, 124
- Scan Settings / Scanner Features, 199
- SCSI print (SBP-2), 66
- Search Destination, 122, 197
- Security Method, 67
- Selecting the Telephone Line type, 48
- Selection Signal Status, 64
- Select Punch Type, 117
- Select Stapling Position, 117
- Send Settings / Facsimile Features, 125
- Send Settings / Scanner Features, 201
- Separation Line in Combine, 105
- Set Date, 59
- Set Time, 59
- Settings for the Document Server, 120
- Settings Required to Use Document Server, 35
- Settings Required to Use
 - Document Server / Ethernet, 35
- Settings Required to Use Document Server /
 - IEEE 1394 (IPv4 over 1394), 36
- Settings Required to Use Document Server /
 - IEEE 802.11b (wireless LAN), 37
- Settings Required to Use E-mail Function /
 - Ethernet, 22
- Settings Required to Use E-mail Function /
 - IEEE 1394 (IPv4 over 1394), 24
- Settings Required to Use E-mail Function /
 - IEEE 802.11b (wireless LAN), 25
- Settings Required to Use Internet Fax, 18
- Settings Required to Use
 - Internet Fax / Ethernet, 18
- Settings Required to Use
 - Internet Fax / IEEE 1394 (IPv4 over 1394), 19
- Settings Required to Use Internet Fax /
 - IEEE 802.11b (wireless LAN), 21
- Settings Required to Use
 - Network TWAIN Scanner, 32

- Settings Required to Use
 - Network TWAIN Scanner / Ethernet, 32
- Settings Required to Use Network TWAIN Scanner / IEEE 1394 (IPv4 over 1394), 33
- Settings Required to Use Network TWAIN Scanner / IEEE 802.11b (wireless LAN), 34
- Settings Required to Use
 - Scan to Folder Function, 26
- Settings Required to Use
 - Scan to Folder Function / Ethernet, 26
- Settings Required to Use Scan to Folder Function / IEEE 1394 (IPv4 over 1394), 27
- Settings Required to Use Scan to Folder Function / IEEE 802.11b (wireless LAN), 28
- Settings Required to Use
 - the Network Delivery Scanner, 29
- Settings Required to Use the Network Delivery Scanner / Ethernet, 29
- Settings Required to Use the Network Delivery Scanner / IEEE 1394 (IPv4 over 1394), 30
- Settings Required to Use the Network Delivery Scanner / IEEE 802.11b (wireless LAN), 31
- Settings Required to Use
 - the Printer/LAN-Fax, 15
- Settings Required to Use
 - the Printer/LAN-Fax / Ethernet, 15
- Settings Required to Use the Printer / LAN-Fax / IEEE 1394 (IPv4 over 1394), 16
- Settings Required to Use the Printer / LAN-Fax / IEEE 802.11b (wireless LAN), 17
- Setup IEEE 802.11b, 12
- Setup Wireless LAN, 12
- Shortcut R/E, 96
- Signal Control, 64
- Simplified Screen: Finishing Types, 118
- SIP Settings, 137
- Size (Background Numbering), 106
- Size (Date Stamp), 112
- Size (Page Numbering), 113
- Slip Sheet Tray, 57
- SMB Computer Name, 62
- SMB Work Group, 62
- SMTP Authentication, 71, 268
- SMTP Reception File Delivery Settings, 129
- SMTP Server, 71
- Special Senders to Treat Differently, 158
- Specifications, 279
- Specifications for the Main Unit, 279
- Specify Tray for Lines, 131
- SSID Setting, 67
- Stamp Colour:1-4 (User Stamp), 111
- Stamp Colour (Background Numbering), 106

- Stamp Colour (Date Stamp), 112
- Stamp Colour (Preset Stamp), 109
- Stamp / Copier /
 - Document Server Features, 106
- Stamp Format:1-4 (User Stamp), 110
- Stamp Format (Page Numbering), 113
- Stamp Format (Preset Stamp), 108
- Stamp Language (Preset Stamp), 107
- Stamp Position on Designating Page (Page Numbering), 114
- Stamp Position (Page Numbering), 114
- Stamp Setting (Date Stamp), 112
- Stored File E-mail Method, 202
- Stored Reception File User Setting, 129
- Sub Paper Size, 189
- Superimpose (Date Stamp), 112
- Superimpose (Page Numbering), 114
- Switch Reception Mode, 128
- Switch Title of Quick Dial Table, 122, 197
- Switch to Batch, 116
- Symbol Set, 193
- System Auto Reset Timer, 58
- System / Printer Features, 187
- System Settings / Administrator Tools, 77
- System Settings / File Transfer, 70
- System Settings / General Features, 49
- System Settings / Timer Settings, 58
- System Settings / Tray Paper Settings, 53
- System Status/Job List Display Time, 52

T

- Test Print / Printer Features, 183
- Timer Settings / System Settings, 58
- To enter an identification name, 86
- To enter a port number, 87
- To enter a server name, 86
- To enter the search base, 86
- To enter the user name and password, 88
- Tone: Original Remains, 93
- To set authentication, 87
- To set search conditions, 89
- To set search options, 89
- To start SSL communication, 87
- To test the connection, 88
- Transfer Log Setting, 84
- Transmission Speed, 68
- Tray Paper Settings / System Settings, 53
- Tray Paper Size: Tray 2-4, 54
- Tray Switching, 190
- TWAIN Standby Time, 197

U

Update Delivery Server Destination List, 197
User Authentication Management, 82
User Code, 212
User Stamp, 110
Using a Fax Destination as a sender, 225
Using SMB to Connect, 238
Using Utilities to Make Network Settings, 38

W

Wait Time for Next Orig.: Exposure Glass, 199
Wait Time for Next Original(s): SADF, 200
Warm Up Notice, 50
WINS Configuration, 61
WINS Configuration (IEEE 1394), 66
Wireless LAN Signal, 68



Declaration of Conformity

“The Product complies with the requirements of the EMC Directive 89/336/EEC and its amending directives and the Low Voltage Directive 73/23/EEC and its amending directives.”

In accordance with IEC 60417, this machine uses the following symbols for the main power switch:

I means POWER ON.

○ means POWER OFF.

⏻ means STAND BY.

Trademarks

Microsoft®, Windows® and Windows NT® are registered trademarks of Microsoft Corporation in the United States and/or other countries.

Acrobat® is a registered trademark of Adobe Systems Incorporated.

NetWare is a registered trademark of Novell, Inc.

Other product names used herein are for identification purposes only and might be trademarks of their respective companies. We disclaim any and all rights to those marks.

Other product names used herein are for identification purposes only and might be trademarks of their respective companies. We disclaim any and all rights to those marks.

Other product names used herein are for identification purposes only and might be trademarks of their respective companies. We disclaim any and all rights to those marks.

The proper names of the Windows operating systems are as follows:

- The product name of Windows® 95 is Microsoft® Windows® 95
- The product name of Windows® 98 is Microsoft® Windows® 98
- The product name of Windows® Me is Microsoft® Windows® Millennium Edition (Windows Me)
- The product names of Windows® 2000 are as follows:
 - Microsoft® Windows® 2000 Advanced Server
 - Microsoft® Windows® 2000 Server
 - Microsoft® Windows® 2000 Professional
- The product names of Windows® XP are as follows:
 - Microsoft® Windows® XP Professional
 - Microsoft® Windows® XP Home Edition
- The product names of Windows Server™ 2003 are as follows:
 - Microsoft® Windows Server™ 2003 Standard Edition
 - Microsoft® Windows Server™ 2003 Enterprise Edition
 - Microsoft® Windows Server™ 2003 Web Edition
- The product names of Windows® NT are as follows:
 - Microsoft® Windows NT® Server 4.0
 - Microsoft® Windows NT® Workstation 4.0

